



GLOBAL PRODUCT CATALOGUE
LONGYEAR® BITS AND ACCESSORIES

AUGUST 2009



**BOART
LONGYEAR™**

www.boartlongyear.com

THIS PAGE LEFT INTENTIONALLY BLANK

TABLE OF CONTENTS

ABOUT OUR PRODUCTS	4
HISTORY	6
SAFETY	9
PRODUCT RANGE AND OVERVIEW	13
BIT RANGE CHART	18
CUSTOM BIT DESIGN	20
IMPREGNATED DIAMOND BITS	21
IMPREGNATED DIAMOND SHOES	77
SURFACE-SET DIAMOND BITS	85
TSD BITS	101
PCD BITS	107
CARBIDE BITS	115
REAMING SHELLS	121
WEDGING TOOLS	129
DIRECTION DRILLING TOOLS	133
DRILLING GUIDELINES	139
TROUBLE SHOOTING	147
WARRANTY	151

ABOUT OUR PRODUCTS

Boart Longyear is the industry's only integrated drilling services and products provider, combining 24-hour engineering excellence, global manufacturing facilities and the most experienced drilling services group in the business. Our customers rely on our unique ability to develop, field test, and deliver any combination of drilling consumables, capital equipment, and expertise direct to any corner of the world.

Exploration Drilling Products

Boart Longyear is globally recognized as the leader in exploration drilling technology. From the rig to the drill string to the record-breaking Stage[®] 3 diamond coring bit at the bottom of the hole, our customers trust us to deliver the most innovative, advanced, and complete solution available.



DIAMOND PRODUCTS

- Surface set bits
- Impregnated bits
- Reamers
- Casing shoes
- PCD bits
- Carbide bits



Q[®] WIRELINE COMPONENTS

- Core barrel assemblies
- Water swivels and hoisting plugs
- Subs and adaptors
- Overshots and recovery tools
- Wrenches

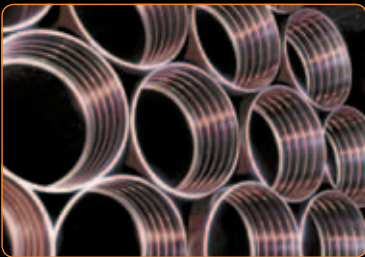

RODS AND CASING

- Q[®] and Patented RQ[®] Drill Threads
- Coring Rod
- Casing

RC CONSUMABLES

- Rod
- Swivels
- Swivel Accessories
- Subs



EXPLORATION DRILL RIGS

- Surface core drills
- Underground core drills
- Multi-purpose drills
- Reverse circulation drills

ABOUT OUR PRODUCTS

In addition to our exploration drilling technology, Boart Longyear also engineers and manufactures world-class drill rigs and consumables for construction, overburden and percussive drilling.

Construction Drill Rigs

- DeltaBase® Site investigation and sampling drills
- DeltaBase® Multi-purpose drills
- DeltaBase® Foundation and construction drills



Construction Drilling Consumables

- DeltaTools™ rods and casing
- DeltaTools™ Bits and casing shoes
- DeltaTools™ Jet grouting tools
- DeltaTools™ Ground freezing tools



Percussive

- Production drill rigs
- Rock drills and breakers
- HRT consumables
 - Threaded bits, rods, couplings, and shank adaptors
 - Tapered bits and rods
 - Integral drill steel
 - Down the hole hammer bits



Aftermarket Support

- Genuine spare parts
- Spare parts kits
- First-aid drill repair boxes
- Maintenance programs



* DELTBASE is a trademark of Boart Longyear, registered in Germany.

HISTORY

BOART PRODUCTS

Our diamond products were originally developed by Anglo American Corporation in the 1930's as a way to commercialize industrial-grade diamonds for the world's leading diamond producer. Boart Products led the research and development program which enabled practical and reliable manufacturing of diamond coring bits.

EARLY SUCCESS IN THE COPPER BELT

The first Boart bits off the line were put to use exploring for copper in Zambia and gold in the Orange Free State, South Africa. The early success of these bits paved the way for widespread adoption of the technology within the industry.

LONGYEAR®

In 1938, the Longyear contract drilling department started using Cast Set diamond bits. Almost immediately after Longyear had the bits in the field, the sales department started receiving inquiries from around the world regarding the availability of the diamond bit.

As our surface-set diamond bit technology developed, Longyear brand bits were put to use around the world. In the 1960's, the Longyear® Q® wireline took the industry by storm and opened the door for widespread adoption of Longyear drilling tools and consumables.

1930

1940

1950

1970

1930s
Diamond bit technology developed by Boart Products

1949
Key manufacturing partnership formed to produce Longyear bits

1955
Longyear develops drilling system for NASA

1938
Longyear Cast Set diamond drill bits launched

1950s
Powder metallurgy first applied to surface-set diamond bits



REVOLUTIONARY ENGINEERING

1974 was an important year for Boart Longyear. Boart International became the sole owner of Longyear. With the new found technical talent and capital investment from Boart International, Longyear became the leading manufacturer of diamond bits.

It was during this transition when engineers in North Bay, Ontario secured a reliable source of high-performance synthetic diamonds which triggered the development of a completely revolutionary bit design – the impregnated-diamond bit. With decades of powder metallurgy experience behind them, Longyear engineers set out to develop a new crown which consisted of synthetic diamonds evenly distributed throughout a composite matrix. This new design could drill further and faster than surface-set bits and it cut through much harder material. By 1980, 75% of our Canadian-produced bits were of the new impregnated type and Longyear was manufacturing diamond bits in more than eight countries.

CONTINUED INNOVATION

Today, there are many marketers of diamond bits and very few of those companies have invested in bit development. Boart Longyear is dedicated to the development of diamond bit technology. Our customers see it in our recent designs – such as Stage® (patent pending) – and they can trust us to deliver unmatched productivity year-after-year.



1980

2000

1978
Synthetic diamond impregnated bits developed by Longyear Canada

2002
Alpha™ titanium-coated diamond technology launched

2007
Stage® waterway design is launched

7

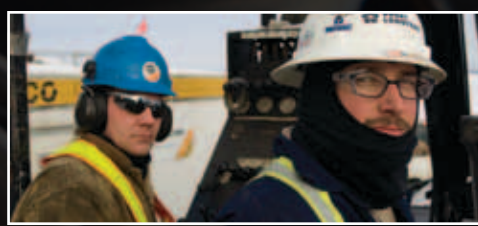
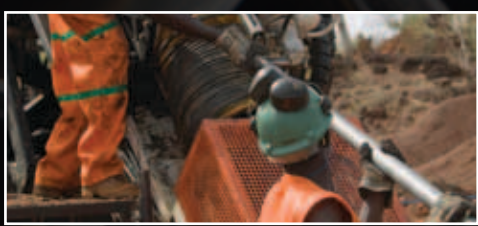

Copyright © 2009 Boart Longyear. All Rights Reserved.

THIS PAGE LEFT INTENTIONALLY BLANK

SAFETY

OVERVIEW10



Safety Identification and Safeguards

Hazard Signal Words

Hazard signal words are used throughout this catalogue and are intended to alert the reader to the existence and relative degree of hazard.

This is the safety alert symbol. It is used to alert you to potential personal injury hazards. Obey all safety messages that follow this symbol to avoid possible injury and death.



DANGER indicates an imminently hazardous situation which, if not avoided, could result in death or serious injury.



WARNING indicates a potentially hazardous situation which, if not avoided, could result in death or serious injury.



CAUTION indicates a potentially hazardous situation which, if not avoided, could result in minor or moderate injury or property damage.

Safety Identification and Safeguards



Read and understand all safety instructions carefully before operating equipment. Failure to follow these instructions may result in serious personal injury or death.

- Keep clear of rotating equipment. Never wear any loose clothing which could become tangled in the machine.
- Keep guards installed and maintained in good working order.
- Always keep the work area clean.
- Avoid dangerous working environments.
- Do not operate equipment while under the influence of drugs, alcohol or medication.
- Keep visitors a safe distance away from the work area.
- Wear personal protective equipment such as a hard hat, safety glasses and steel toed work boots.
- Always wear hearing protection when operation equipment with noise levels are at or above 85 dBA. Double hearing protection may be necessary when operating percussive drills.
- Read and understand the operations manual and labels affixed to the machine.
- Use only Boart Longyear replacement parts. Failure to do so could cause severe damage to the machine or the operator, and may void your warranty.
- Use only qualified service technicians. Failure to do so could cause severe damage to the machine or the operator, and may void your warranty.
- Ensure that the drill and accessories fully comply with applicable local safety and health regulations.
- Do not exceed rated capacity of any piece of equipment.
- Never rotate the drill rods with a rod joint located behind or above the chuck.
- Do not change or alter the drill, its components, optional equipment or accessories without prior approval from Boart Longyear.
- Unauthorized alteration may void the warranty, render the equipment unsafe or result in decreased performance.
- Before operating any controls, be certain you know what function they control and the ramifications of that function.
- Before operating any hoist, ensure the rope is free and clear to travel.
- When hoisting/lowering rods, make sure the hoisting cable is in complete tension before releasing the chuck.
- For additional information on training or start up, contact your Boart Longyear representative.



THIS PAGE LEFT INTENTIONALLY BLANK

PRODUCT RANGE AND OVERVIEW

SYSTEM OVERVIEW..... 14

- Q® WIRELINE COMPONENTS..... 14
- Q®TK WIRELINE COMPONENTS..... 14
- Q®3 WIRELINE COMPONENTS..... 15
- Q®TT WIRELINE COMPONENTS..... 15

PRODUCT RANGE..... 16

BIT RANGE CHART..... 18

CUSTOM BIT DESIGN..... 20



SYSTEM OVERVIEW

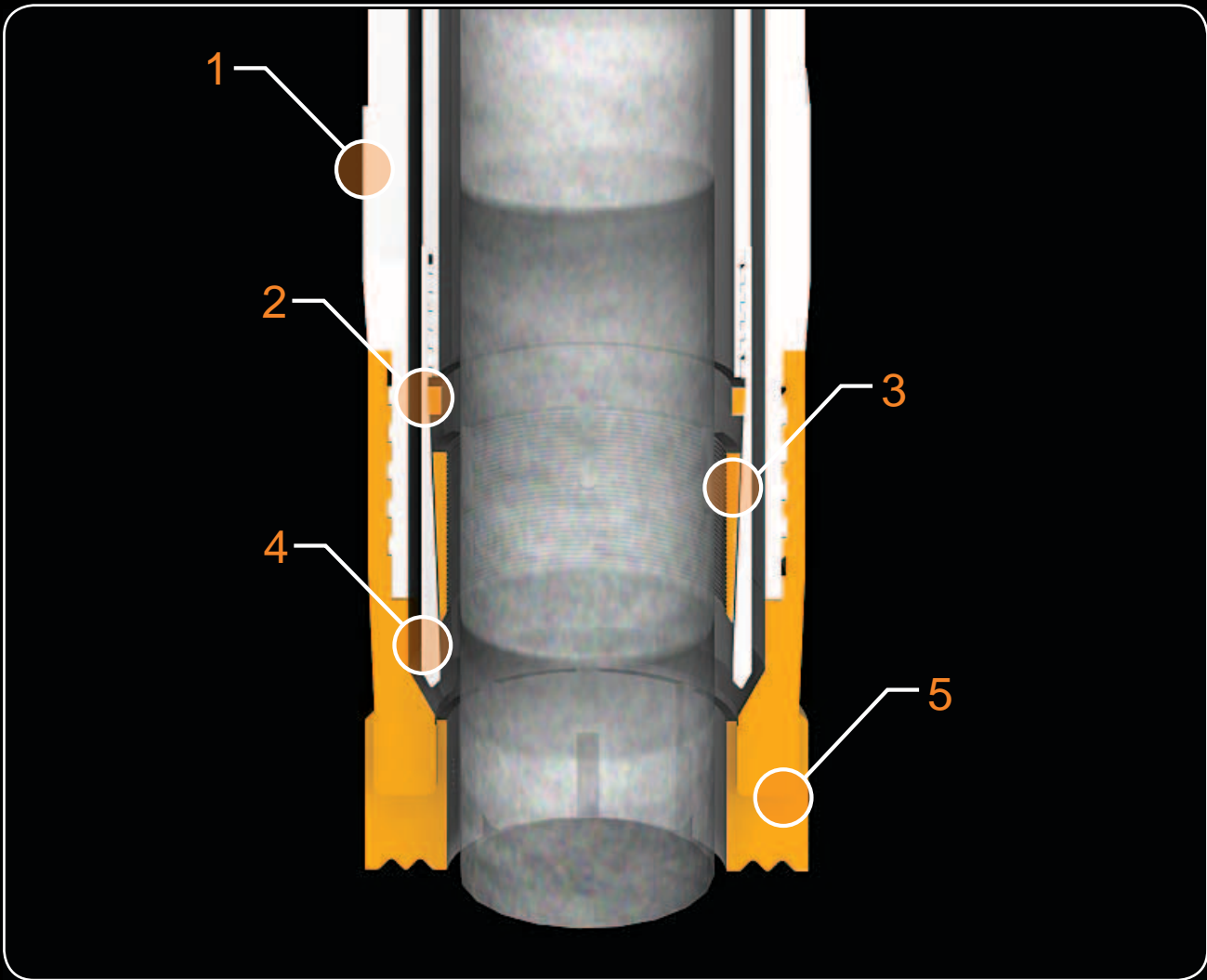

Q® & Q®TK SYSTEM

REAMING SHELL (1)

The reaming shell is used to maintain a specified hole diameter as the rod string descends. In addition the reaming shell helps to stabilize the rod string.

STOP RING (2)

The Stop Ring is hardened steel snap ring designed to seat into a mating groove, and retain the core lifter in the core lifter case.

CORE LIFTER (3)

The core lifter is a hardened steel, split collar with a tapered body that mates to a tapered socket in the core lifter case. The core lifter is constricted against the core sample and retains it after it has broken, allowing retrieval to surface.

CORE LIFTER CASE (4)

The core lifter case mates to the inner-tube and houses the core lifter in a tapered socket which controls movement of the core lifter.

CORE DRILLING BIT (5)

The core drilling bit attaches to the outer tube and is the cutting-edge at the bottom a drill string. Coring bits are available in a broad range of configurations which are specifically designed to perform in an equally-broad range of drilling conditions

Standard coring bits available for all types of drilling.

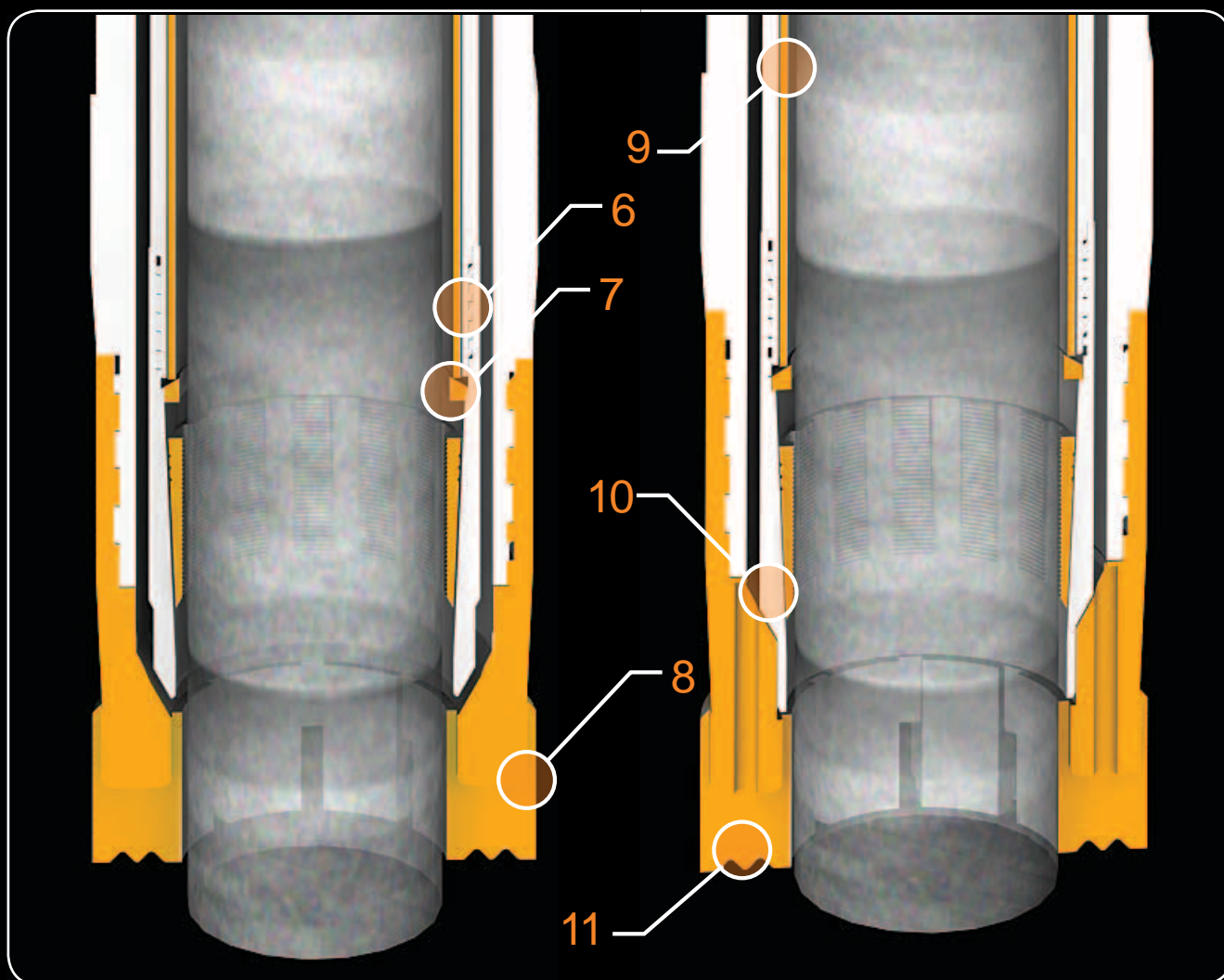

Q[®]3 SYSTEM OPTION

The Q[®]3 system is designed to improve core recovery in soft or highly broken ground conditions.

STOP RING (6)

Retains the inner-tube and the liner.

INNER TUBE LINER (7)

The inner-tube liner is used when collecting highly fractured or soft core samples.

Q[®]3 CORE DRILLING BIT (8)

Core bits made for a 3 tube core barrel system are designed to provide a smaller-diameter core sample which allows the core to feed into the extra tube.

Q[®] TT SYSTEM OPTION

The Q[®] TT system is similar to the Q[®]3 system but includes a specialized core lifer case and bit. These components enable change in the water flow by creating a seal which routes water flow away from the inner-tube – further improving core recovery.

INNER TUBE LINER (9)

The inner-tube liner is used to improve core collection of highly fractured and soft core samples.

CORE LIFTER CASE (10)

A specially designed piloted core lifter case that improves core recovery and reduces core washing by directing fluid flow away from the ID of the core bit.

Q[®] TT CORE DRILLING BIT (11)

Core bits made for a 3-tube core barrel system are designed to accommodate a pilot core lifter case. This style of core bit requires face discharge ports or deep ID waterways.

PRODUCT RANGE



IMPREGNATED DIAMOND BITS

The impregnated diamond bit is used for cutting holes in medium to ultra hard formations. A variety of variations are available to maximize drill life and penetration.

The crown is made up of a metal powder and diamond matrix that wears away during the drilling process and exposes new layers of diamonds, renewing the cutting points.



SURFACE SET CORING BITS

Surface set bits are typically used in softer formations. They utilize a single layer of natural diamonds set in a hard matrix and can be manufactured in many crown profiles to fit the different types of formations.



TSD BITS

The TSD bit is used for fast penetration in soft/medium rock formations. TSD's are a cost effective alternative for large stone surface set bits.



PCD BITS

PCD bits are made for cutting softer formations at high penetration rates. They typically have round PCD cutters that can be replaced, extending the life of the bit.

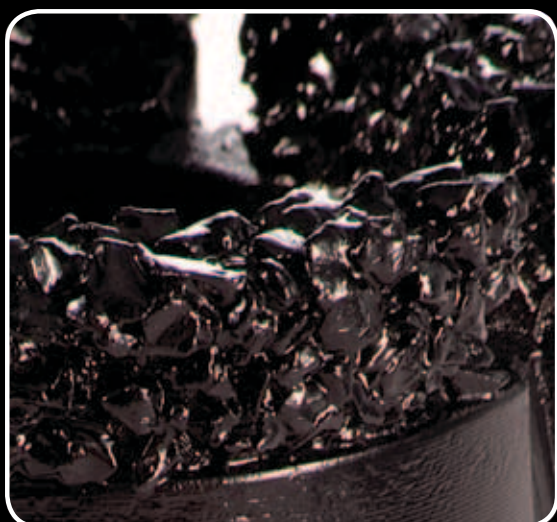

CARBIDE CHIP

The carbide chip bit is a general purpose bit for geo-technical applications used primarily in soft formations. This is a cost effective alternate to carbide tooth bits.



DIRECTIONAL BITS

Directional bits are used with down hole motors to steer the drill string in different directions.

BIT RANGE CHART

BIT RANGE CHART

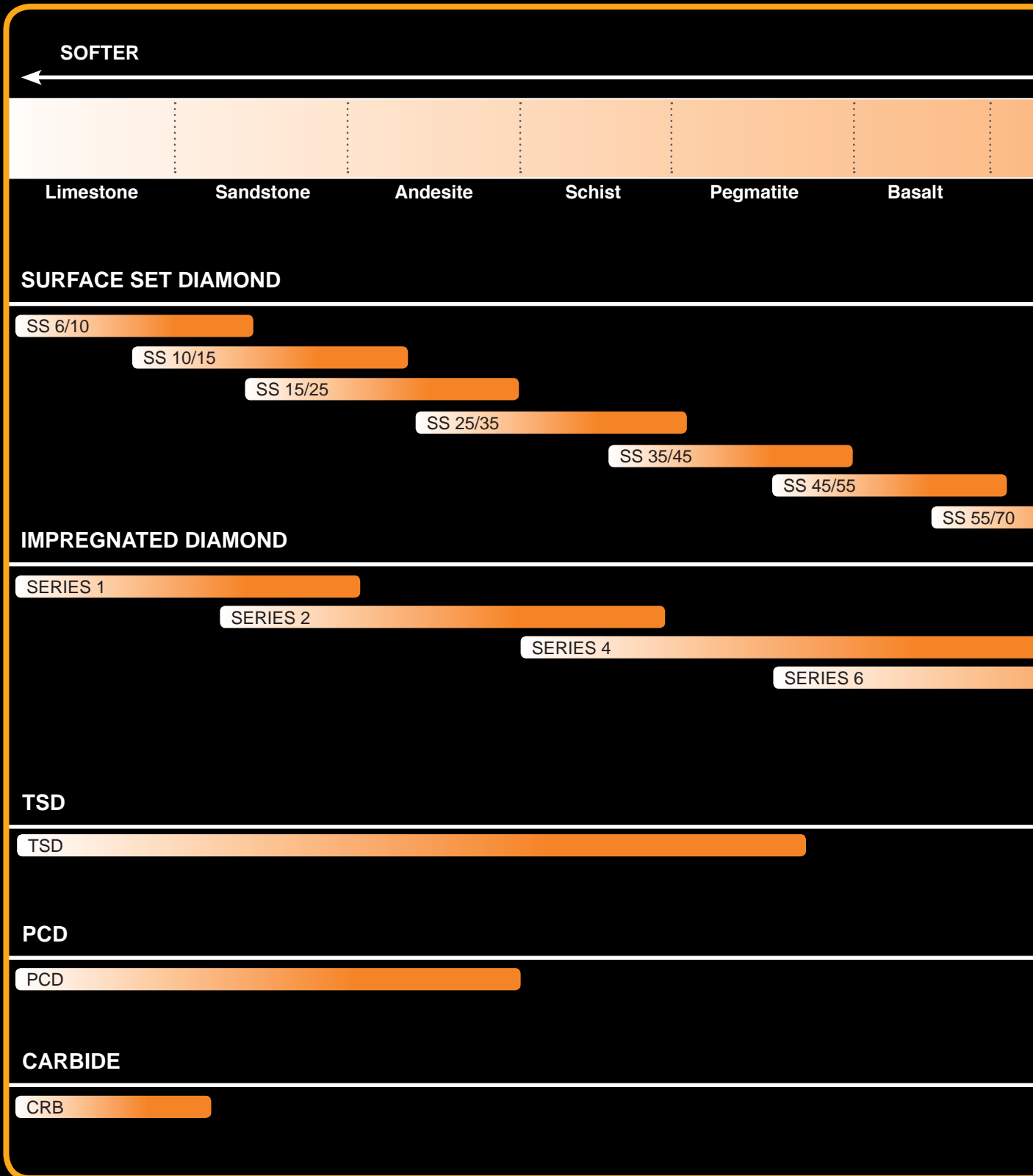

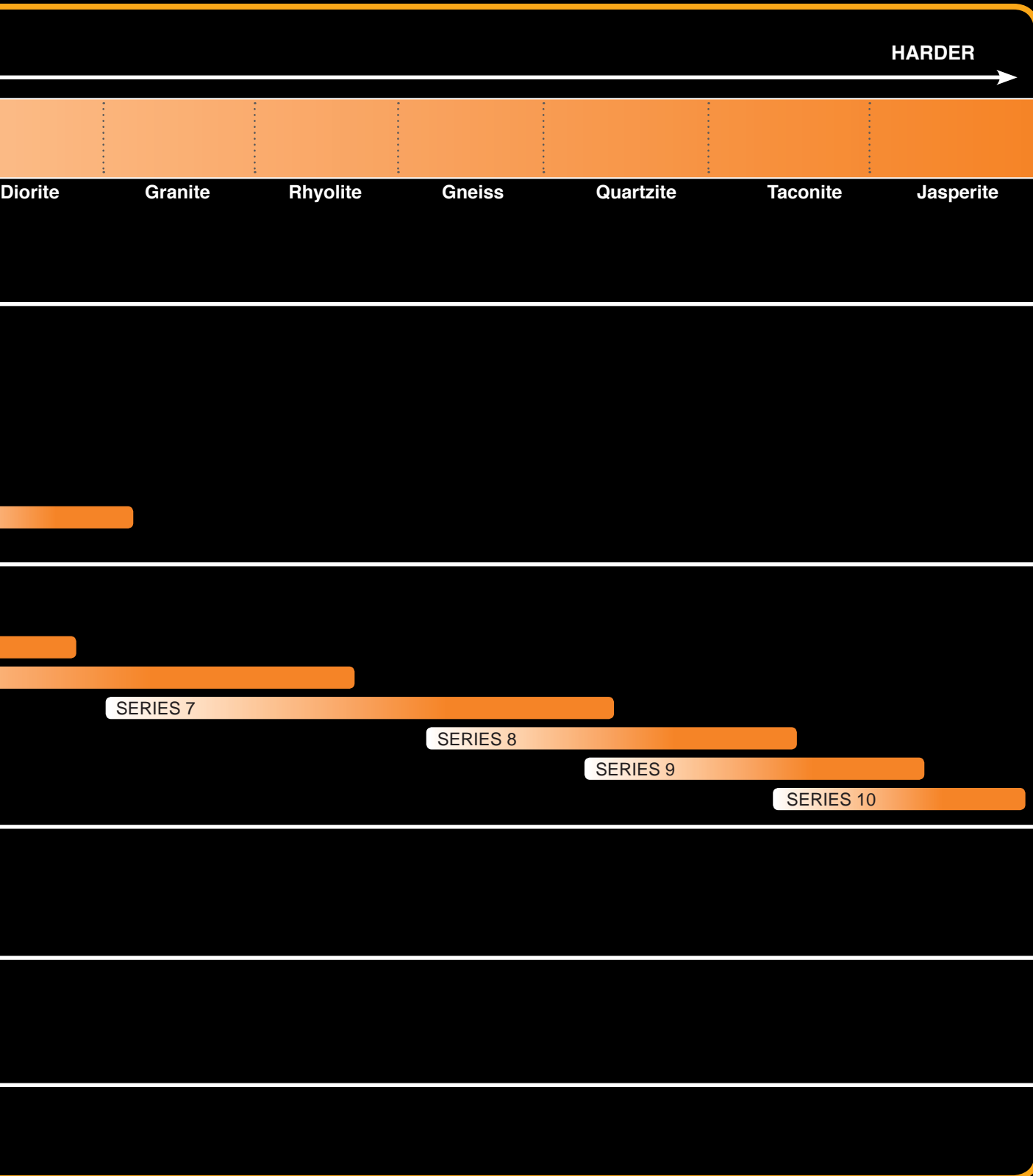

Conditions are often encountered where formations change repeatedly within a very short interval of drilling. Under such circumstances, select a bit which will cut the hardest of the expected formations, and adjust drill rates as abrasive rock is encountered to protect the bit from excessive wear rates.

For details about bit selection as well as custom exploration bits, please contact your regional sales representative.

CUSTOM BIT DESIGN

CUSTOM SOLUTIONS FOR ANY CONDITION

Experience has proven that some ground conditions require custom bits. Boart Longyear engineers are available to help you quickly solve site-specific problems which would otherwise cost you time and money.

COMMON DESIGN MODIFICATIONS INCLUDE:

- Thread Type
- OD Size
- Crown Profiles for surface set bits
- Solutions for special rock conditions
- Cutter size for PCD bits

For details about bit selection as well as custom bits, please contact your regional sales representative.

LONGYEAR® IMPREGNATED BITS

IMPREGNATED BIT OVERVIEW 22

IMPREGNATED BIT DESIGN OVERVIEW	22
IMPREGNATED BIT SELECTION	24
MATRIX OVERVIEW	26
WATERWAY OPTIONS	27

STAGE® OVERVIEW 28

TECHNICAL DATA	28
FIELD TEST DATA	29

PART NUMBERS 30

IMPREGNATED BIT ORDERING DETAILS	30
Q® SIZES	31
METRIC SIZES	61



IMPREGNATED BIT OVERVIEW

IMPREGNATED BITS

The combination of diamond and matrix determine the performance of an impregnated bit. The simultaneous erosion of the matrix and the diamonds makes the bit self sharpening. Boart Longyear uses a special matrix that provides optimal performance.

COATED SYNTHETIC DIAMONDS

Boart Longyear utilizes CSDs so the diamonds stay in the bit matrix longer. Longer adhesion allows more of the diamond surface to be exposed and enables faster cutting. The coating also protects the diamonds from degradation during the bit production process.

CROWN HEIGHT

Boart Longyear offers three different impreg depths of 6mm, 9mm, 12mm, and 25mm (with the patent-pending Stage® waterway). The longer crown heights provide improved bit stability and reduced vibrations, enhancing bit performance and life.

REINFORCED RIB PATTERN

Extra-wide flat surfaces on the ID and OD shoulders strengthen the gauges, reducing bit face wear and promoting better cutting characteristics. This contributes to higher performance and longer bit life.

MAGNUM GAUGE

Natural diamonds have been replaced with TSD (thermally stable diamond) pins. In addition, our unique gauge-keeping pattern provides improved stability and wear resistance, resulting in extended bit life. With a pure synthetic diamond design, drillers do not need to request an 'All Synthetic' or 'No Natural Diamond' bit for diamond exploration.

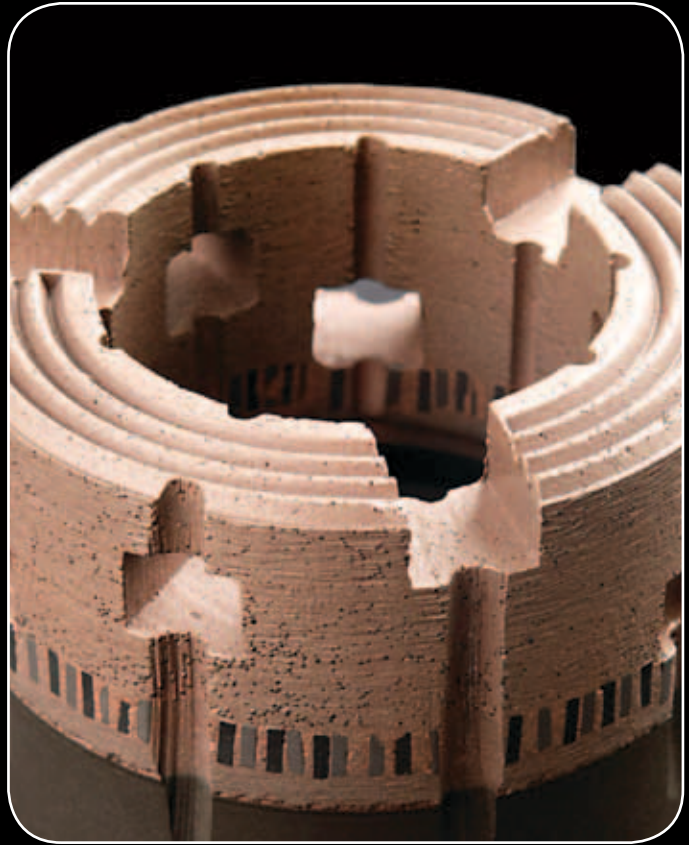

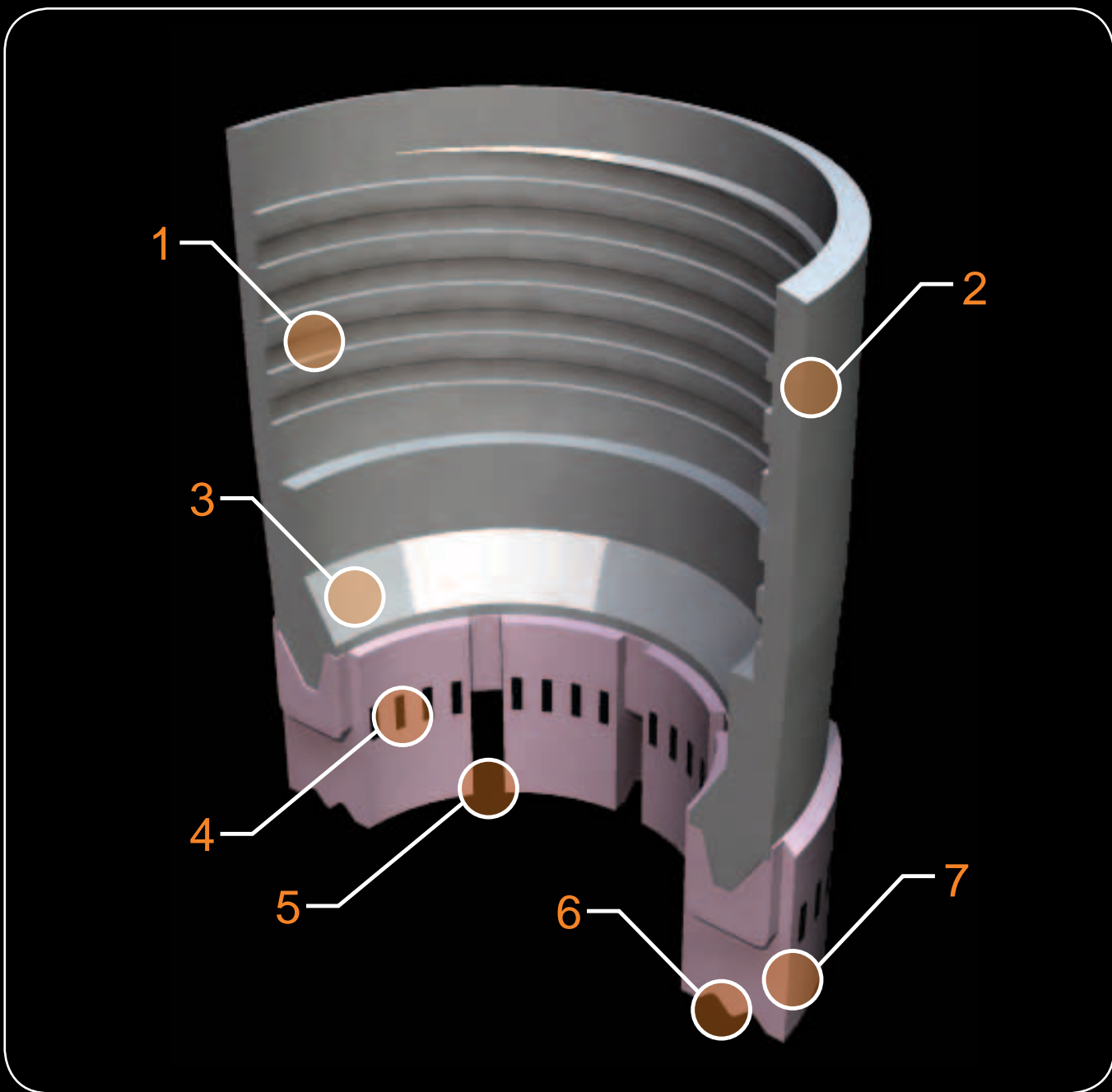

THREADS (1)

Precision cut industry standard bit threads.

BIT SHANK (2)

Made of high-quality steel and machined in small batches to maintain manufacturing standards

CORE LIFTER CASE SEAT (3)

Supports core lifter case when breaking core

TUNGSTEN CARBIDE AND TSD PINS (4)

Protect the integrity of the crown

WATERWAYS (5)

Controls fluid flow around the cutting edge of the bit

BIT FACE (6)

Optimum design allows for quick startup of a new bit

CROWN (7)

Available in an extremely wide variety of formulations, the crown is the cutting edge of the bit.

LONGYEAR® IMPREGNATED BIT RANGE

Selecting the right bit for the job is not as difficult as it may seem. Just assess the speed and power capability of your drill for the size and depths of the holes to be drilled and gain as much knowledge as you can about the expected rock types and down-hole conditions; then follow the guidelines below.

The Boart Longyear bit range is manufactured in sizes to suit Boart Longyear's and competitors' core barrels, and to accommodate oversize/undersize requirements.

Boart Longyear recognizes that drilling conditions are often encountered where formations change repeatedly within a very short interval of drilling. Under such circumstances, the lowest bit which

will cut the hardest of the expected formations is recommended, and some discretion should be exercised to restrict penetration rates in any abrasive rocks encountered to protect the bit from excessive wear rates. However, if hole deviation becomes a problem, a higher bit, combined with reduced penetration rates, may contribute to bringing it under control.

In certain instances, particularly in broken ground conditions, a mud program should be developed to maintain hole stability.

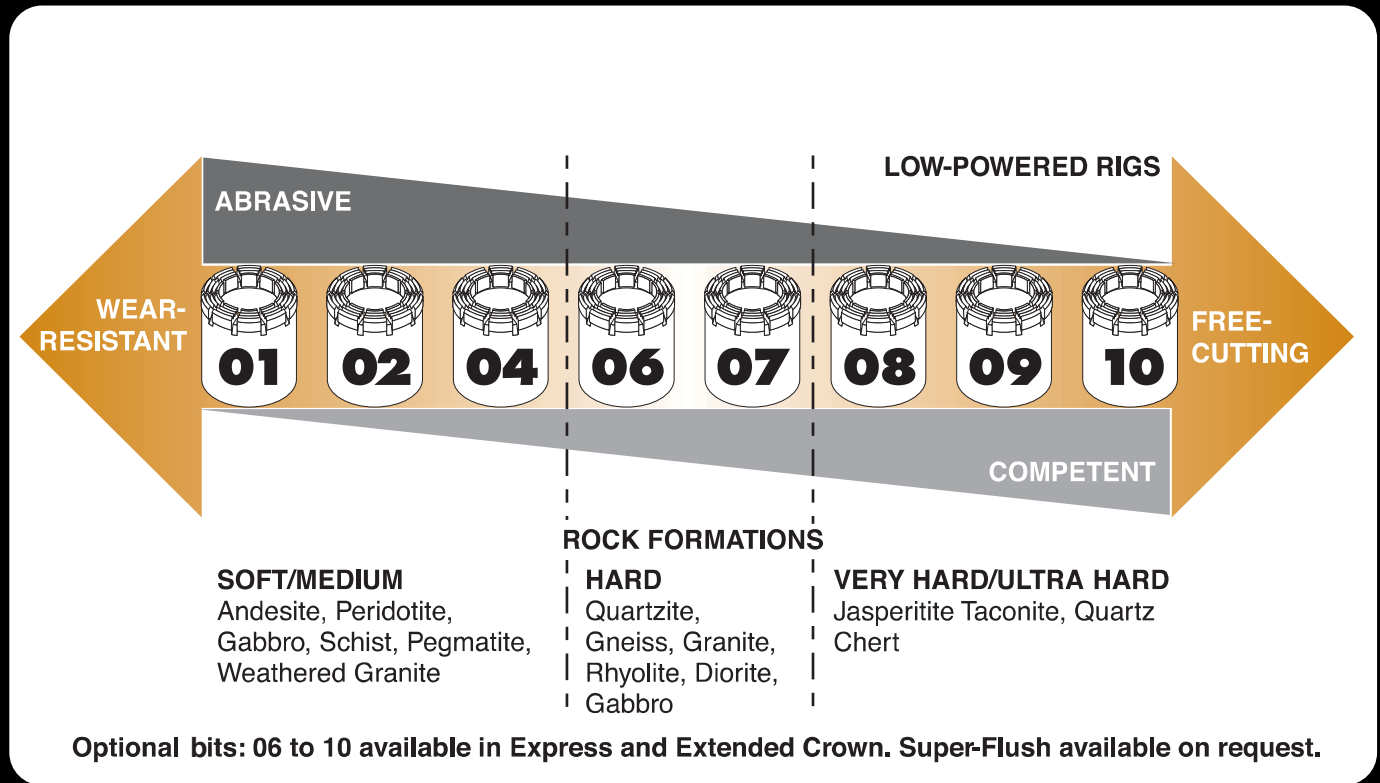

IMPREGNATED BIT SELECTION GUIDE

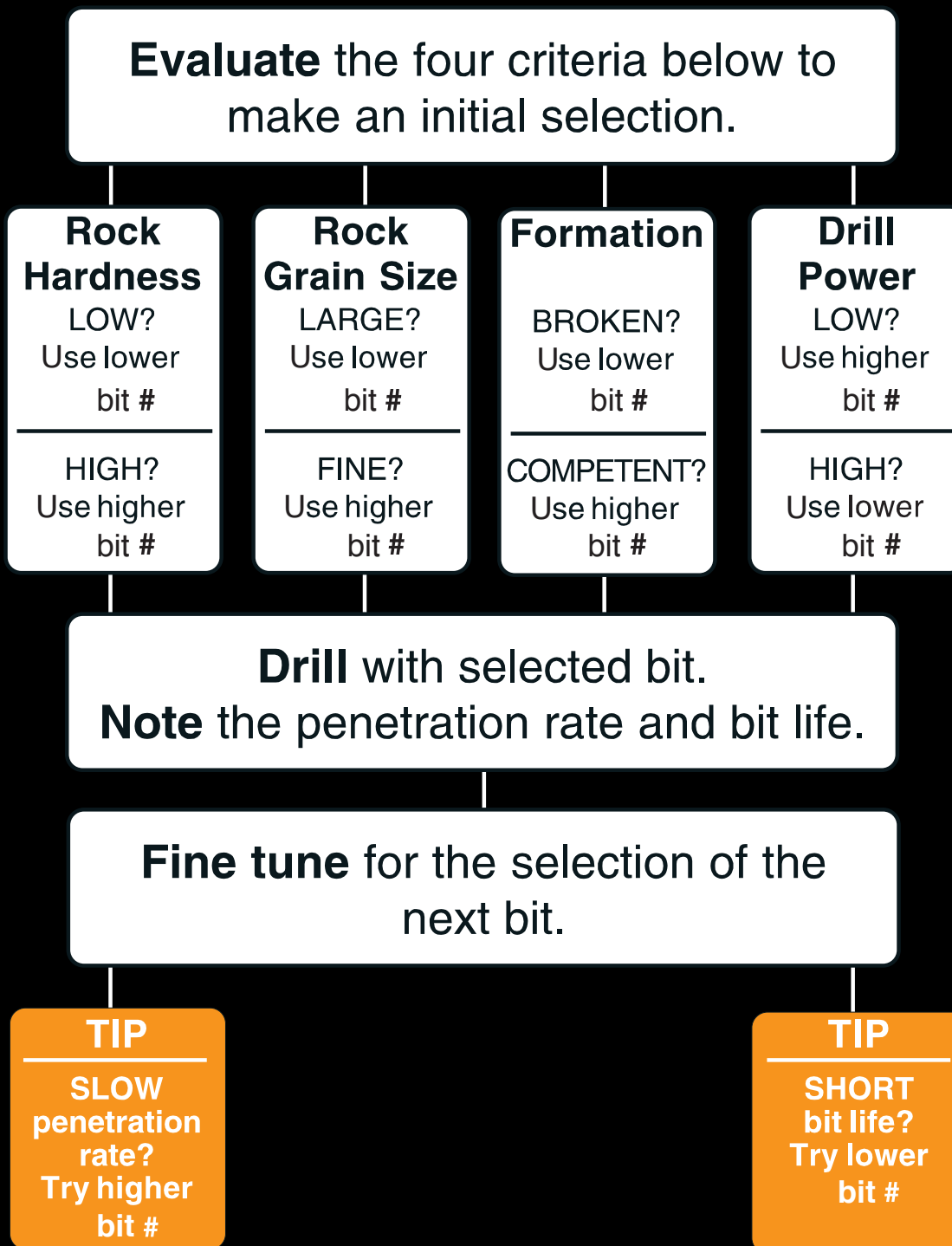

IMPREGNATED BIT OVERVIEW

MATRIX DESIGN OVERVIEW

Boart Longyear offers the most accepted range of impregnated bit matrices. Long respected as the industry rule, our Series matrix selection provides an easy to select and dependable foundation for your drilling needs.

When available, Longyear® impregnated bits matrices can be ordered in Abrasive, Standard and Competent formulations.

ABRASIVE bits are for broken, abrasive drilling conditions or for harder rock with broken, abrasive conditions.

COMPETENT bits are free-cutting for fast penetration in very hard, competent rock or for use on lower-powered rigs and in geo-technical applications.



SERIES 1 BIT

Series 1 is made with an extremely wear resistant matrix for long life in soft formations, but can also be used in medium broken formations.



SERIES 7 BIT

Series 7 is made to cut medium hard formations. Series 7 is a good choice for formations that have a mixture of medium hard and hard conditions.



SERIES 2 BIT

Series 2 is made to cut soft formations and large grain medium formations with excellent bit life. Is also a good choice for cutting concrete with reinforcing.



SERIES 8 BIT

Series 8 is a general purpose bit for cutting hard formations. It is also a good choice to improve drilling production of medium hard formations.



SERIES 4 BIT

Series 4 is a good choice for cutting soft to medium formations. Series 4 is also a good alternative to the Series 6 for high torque low rpm rigs.



SERIES 9 BIT

Series 9 is a free cutting formula for cutting very hard and ultra hard formations. This is a good choice when drilling medium hard formations with a low torque drill rig.



SERIES 6 BIT

Series 6 is a general purpose formula for cutting formations in the medium hard range. Series 6 also works well in formations of variable hardness.



SERIES 10 BIT

Series 10 is made to cut ultra hard fine grain formations. This is an alternative when drilling very hard formations with a low torque drill rig.

IMPREGNATED BIT WATERWAY OPTIONS

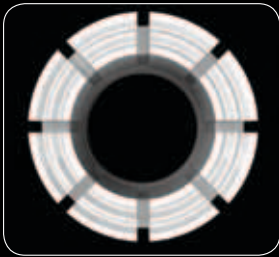

STANDARD WATERWAYS

Recommended for general purpose coring operations. Available with various numbers of waterways and waterway widths.

Also available in WIDE waterway configurations.



TAPERED WATERWAYS (TW)

Recommended for soft and broken ground applications where blocking of regular waterways is possible. The jetting effect of the taper tends to keep the waterway free of cuttings and reducing pressure across the bit face.

Also available in WIDE waterway configurations.



EXPRESS WATERWAYS (EX)

Provides greater penetration rates in competent formations. The hydraulic effect of the design improves the flushing efficiency and controls bit-rock contact. The allows for reduced torque and increased penetration rate. When drilling at depth and rig power is declining, the express design is recommended.

Also available in WIDE waterway configurations.



DEEP ID WATERWAYS (DD)

Recommended in loss-of-circulation applications. Deep ID waterways prevent the vacuum effect which pulls the core lifter case into the bit causing a loss of water flow to the bit face. The extra clearance allows water to flow past the bit face and the additional ID waterway area reduces jetting and core washing.

Also available in WIDE waterway configurations.



FACE DISCHARGE WATERWAYS (FD)

Recommended for very soft and broken ground or swelling core applications with Q[®]3 barrels. The face discharge ports offer excellent flushing to prevent blockages in the waterway channels by reducing pressure to the ID and redirect fluid to the face of the bit.

Also available in WIDE waterway configurations.

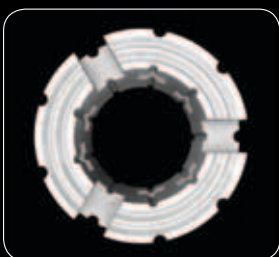

STAGE[®] WATERWAYS

The new patent-pending Stage[®] waterway design is recommended for all drilling applications. The design has proven to be highly efficient, allowing for superior flushing capability and highly productive penetration rates.

Bits utilizing the Stage[®] waterway are currently only available in a impreg height of 25.4mm.

STAGE® WATERWAY OVERVIEW

STAGE® WATERWAYS

The Stage® waterway option represents a new way of looking at bit crown design. One look and a driller knows it's different – the massive crown, increased cutting area and incredibly stable window design – Stage® is changing the industry.

The 25.4mm is achieved using a patent-pending window-waterway design. As the crown height is worn down through normal usage, a new stage is revealed. The windows of the new stage open up to form waterways. Each new stage of windows will open before the previous stage finishes.

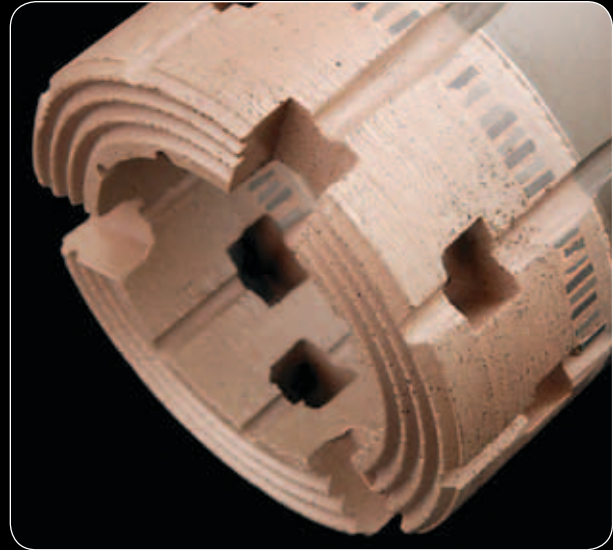

STAGE® WATERWAY FEATURES

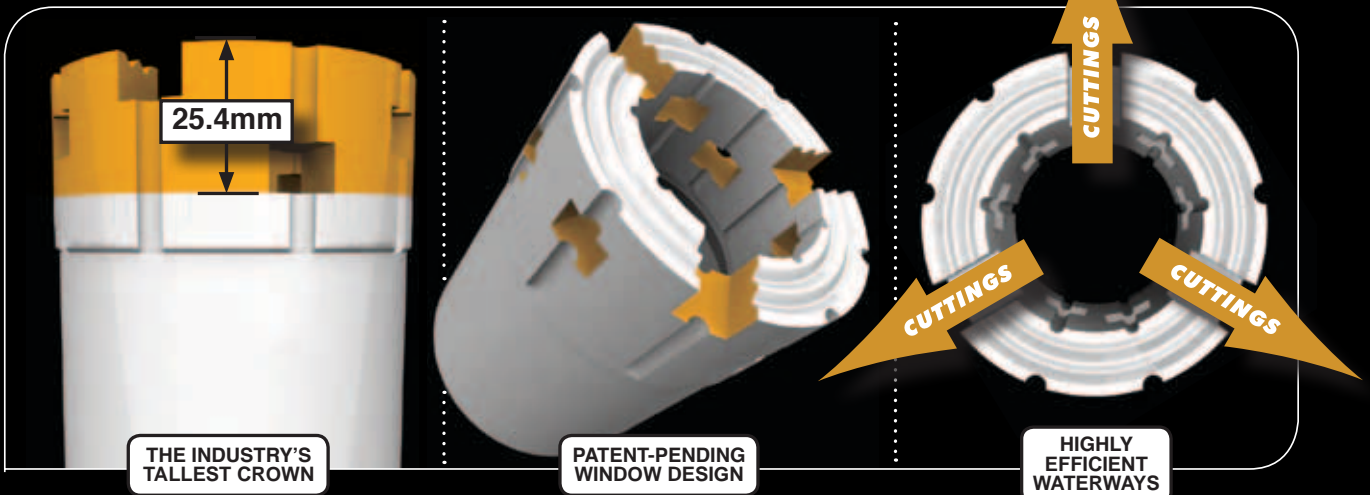

Longyear® bits configured with the Stage® waterway design are more structurally sound than any diamond impregnated bit currently on the market – at any height.

The window design has proven to be highly efficient, allowing for superior flushing capability and highly productive penetration rates.

The longer crown height of the Stage® adds stabilization to the drill string which results in less deviation at the bottom of the hole and increases both reamer life and overall productivity.

STAGE® WATERWAY FIELD SAVINGS

STAGE® 3 CORING BIT 8-MONTH FIELD RESULTS

After more than a year in the field, the Stage® coring bit has broken bit life records around the world. The design is quickly being recognized for its cost-saving operational impact.

In Sudbury, Canada, a major mine operation realized same-drill cash savings of more than

\$45,000CDN within an 8-month period – by making the switch to Stage® 3 bits.

By increasing bit life, rod tripping is reduced per shift and overall core recovery is improved. Savings are seen as the cost-per-meter falls and drill productivity improves.

ACTUAL PERFORMANCE DATA (1 DRILL / 190 BITS / 9781M)

SITE CONDITIONS: “Ultra Hard” Felsic Gneiss / Sudbury, Canada / Up-Hole Drilling

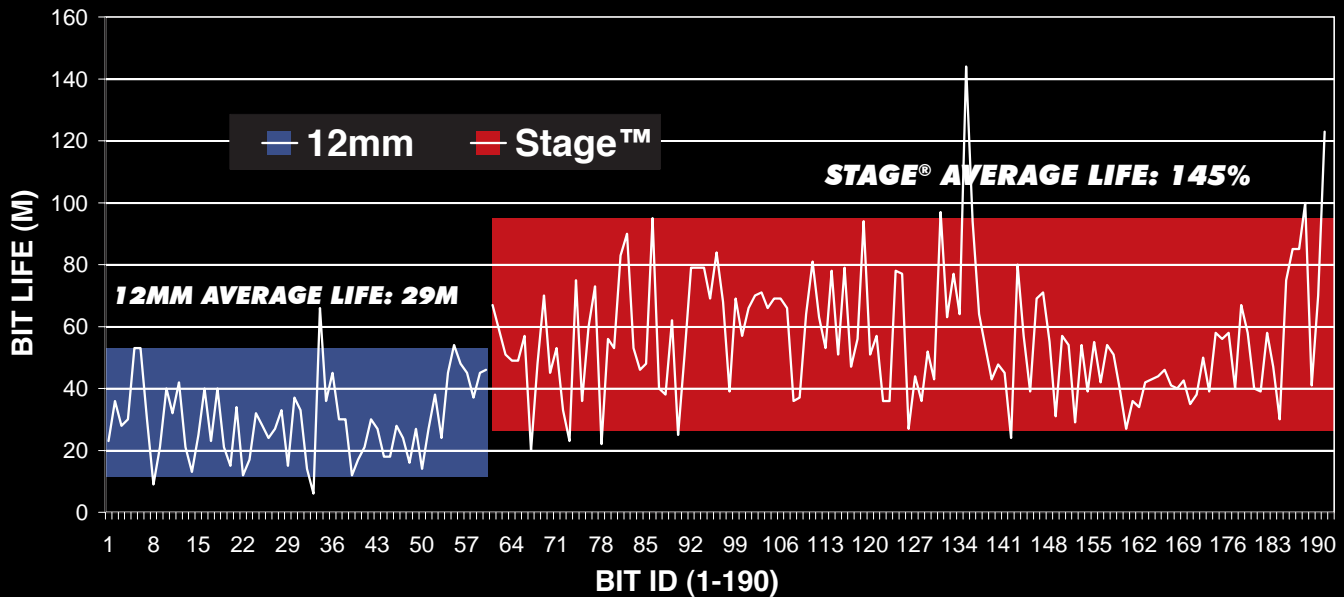

ROD-TRIPPING COST SAVINGS

Hole Depth	Rod Tripping Time Hrs	Rod Tripping Cost	# Trips w/ 12mm	Cost	# Trips w/ 25mm	Cost	Cost Savings w/ Stage™ 3
50	0.5	\$ 35.00	2	\$ 70.00	1	\$ 35.00	\$ 35.00
100	0.75	\$ 52.50	2	\$ 105.00	1	\$ 52.50	52.50
150	1	\$ 70.00	2	\$ 140.00	1	\$ 70.00	70.00
200	1.25	\$ 87.50	1	\$ 87.50	0	\$ N/A	87.50
Total (total Tripping Cost divided by 49 holes)				\$ 19,722.50		\$ 7,717.50	\$ 12,005.00

*All costs reflect individual customer operating and product costs.

Meters Drilled: 9781	Total Bit Cost
12mm Est. Total Cost	\$ 134,800
Stage™ 3 Est. Total Cost	\$ 101,150
\$33,650.00	

TOTAL SAVINGS (ONE DRILL) **\$45,655 (30%)**

IMPREGNATED BIT ORDERING DETAILS

READING A LONGYEAR® IMPREGNATED DIAMOND BIT DESCRIPTION:

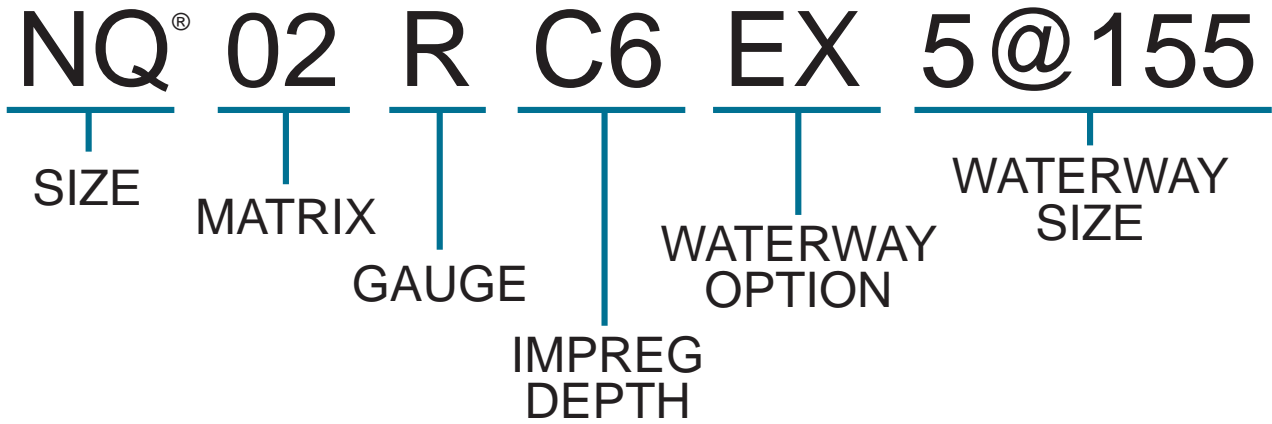

SIZE

Longyear® bits are available in all standard drilling sizes as well as a number a region-specific sizes.

MATRIX

The Longyear® impregnated diamond bit line has been designed to manage an extremely wide variety of ground conditions. **See page 26 for complete details.**

GAUGE

Longyear® bits are available in four standard gauge configurations.

- STANDARD GAUGE (S)
- EQUAL TO REAMING SHELL GAUGE (R)
- LESS THAN REAMING SHELL GAUGE (-R)
- OVERSIZED OD (OS, INCHES)

IMPREG DEPTH

Longyear® impregnated diamond bits are currently available in four standard impreg depths of 6mm, 9mm, 12mm and 25mm.

WATERWAY OPTION

Longyear® impregnated diamond bits are available in six specially designed waterway options:

- STANDARD
- TAPERED (TW)
- EXPRESS (EX)
- DEEP ID (DD)
- FACE-DISCHARGE (FD)
- STAGED

WATERWAY SIZE

Longyear® impregnated diamond bits offer the widest variety of waterway sizes in the industry. The description represents the number of waterways and the waterway size:

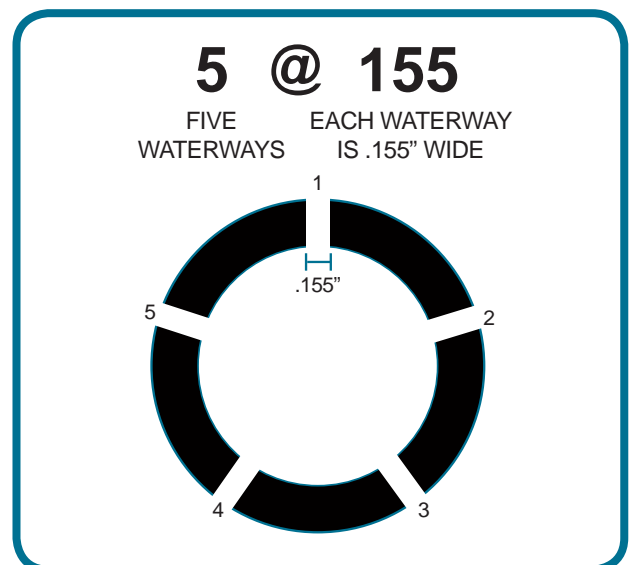

AQ® & AQ®TK

AQ®

ITEM	DESCRIPTION	SERIES	GAUGE	CROWN HEIGHT	WATERWAY OPTION	WATERWAY SIZES
4050055	BIT AQ 02 R C6 5@155	2	R	6mm		5@155
4051282	BIT AQ 06 R C9 EX 6@125	6	R	9mm	EX	6@125
4052881	BIT AQ 06 S C12 6@125	6	S	12mm		6@125
4050052	BIT AQ 08 R C9 6@125	8	R	9mm		6@125
4050276	BIT AQ 08 R C9 EX 6@125	8	R	9mm	EX	6@125
4052279	BIT AQ 08COM S C9 6@155	08COM	S	9mm		6@155
4052233	BIT AQ 09 S C12 6@125	9	S	12mm		6@125
4050067	BIT AQ 10 R C9 6@125	10	R	9mm		6@125
4052281	BIT AQ 10COM S C9 6@155	10COM	S	9mm		6@155

AQ®TK

ITEM	DESCRIPTION	SERIES	GAUGE	CROWN HEIGHT	WATERWAY OPTION	WATERWAY SIZES
4052636	BIT AQTK 01 S C6 5@155	1	S	6mm		5@155
4052558	BIT AQTK 02 S C6 5@155	2	S	6mm		5@155
4051398	BIT AQTK 06 S C9 6@125	6	S	9mm		6@125
4052438	BIT AQTK 07ABR S C12 6@125	07ABR	S	12mm		6@125
4052096	BIT AQTK 07 S C9 6@125	7	S	9mm		6@125
4052822	BIT AQTK 07 S C12 EX 6@125	7	S	12mm	EX	6@125
4051730	BIT AQTK 07COM S C9 6@125	07COM	S	9mm		6@125
4053949	BIT AQTK 07COM S C12 6@187	07COM	S	12mm		6@187
4053922	BIT AQTK 08ABR -R C25 STG3	08ABR	-R	25mm		Staged
4051825	BIT AQTK 08ABR S C9 6@125	08ABR	S	9mm		6@125
4052421	BIT AQTK 08 S C12 6@125	8	S	12mm		6@125
4052048	BIT AQTK 08COM S C9 6@125	08COM	S	9mm		6@125
4053586	BIT AQTK 08COM S C12 8@250	08COM	S	12mm		8@250
4054015	BIT AQTK 09 -R C25 STG3	9	-R	25mm		Staged
4051835	BIT AQTK 09 S C12 6@125	9	S	12mm		6@125
4053141	BIT AQTK 09 S C12 5@187	9	S	12mm		5@187
4053855	BIT AQTK 09COM -R C25 STG3	09COM	-R	25mm		Staged
4052189	BIT AQTK 09COM S C12 6@125	09COM	S	12mm		6@125
4053140	BIT AQTK 09COM S C12 5@187	09COM	S	12mm		5@187
4052360	BIT AQTK 09COM S C12 EX 6@125	09COM	S	12mm	EX	6@125
4051581	BIT AQTK 10 S C9 EX 6@125	10	S	9mm	EX	6@125
4052462	BIT AQTK 10 S C12 6@125	10	S	12mm		6@125
4052517	BIT AQTK 10 S C12 EX 5@100	10	S	12mm	EX	5@100
4054187	BIT AQTK 10COM -R C25 STG3	10COM	-R	25mm		Staged
4052019	BIT AQTK 10COM S C9 6@125	10COM	S	9mm		6@125

BOART LONGYEAR OFFERS COMPLETE CUSTOM DESIGN SERVICES. SEE PAGE 20 FOR DETAILS.

ITEM	DESCRIPTION	SERIES	GAUGE	CROWN HEIGHT	WATERWAY OPTION	WATERWAY SIZES
4050121	BIT BQ 01ABR S C6 7@187	01ABR	S	6mm		7@187
4050070	BIT BQ 02 R C6 7@155	2	R	6mm		7@155
4053729	BIT BQ 02 S C6 6@125	2	S	6mm		6@125
4052061	BIT BQ 02 S C9 7@155	2	S	9mm		7@155
4053358	BIT BQ 02 S C9 8@187	2	S	9mm		8@187
4050073	BIT BQ 04 R C6 7@155	4	R	6mm		7@155
4050130	BIT BQ 04 S C6 7@155	4	S	6mm		7@155
4053106	BIT BQ 04 S C6 8@187	4	S	6mm		8@187
4054040	BIT BQ 06ABR -R C25 STG3	06ABR	-R	25mm		Staged
4051492	BIT BQ 06ABR S C9 8@125	06ABR	S	9mm		8@125
4051654	BIT BQ 06ABR S C12 EX 8@125	06ABR	S	12mm	EX	8@125
4052008	BIT BQ 06ABR S C12 6@187	06ABR	S	12mm		6@187
4053105	BIT BQ 06ABR S C12 8@187	06ABR	S	12mm		8@187
4054169	BIT BQ 06 -R C25 STG3	6	-R	25mm		Staged
4050075	BIT BQ 06 R C9 8@125	6	R	9mm		8@125
4050163	BIT BQ 06 R C9 EX 8@125	6	R	9mm	EX	8@125
4050744	BIT BQ 06 R C9 TW 6@125	6	R	9mm	TW	6@125
4050142	BIT BQ 06 S C9 8@125	6	S	9mm		8@125
4053104	BIT BQ 06 S C12 8@187	6	S	12mm		8@187
4053804	BIT BQ 07ABR -R C25 STG3	07ABR	-R	25mm		Staged
4051014	BIT BQ 07ABR S C9 8@125	07ABR	S	9mm		8@125
4052203	BIT BQ 07ABR S C9 EX 8@100	07ABR	S	9mm	EX	8@100
4053054	BIT BQ 07ABR S C12 6@125	07ABR	S	12mm		6@125
4052007	BIT BQ 07ABR S C12 6@187	07ABR	S	12mm		6@187
4051313	BIT BQ 07ABR S C12 EX 8@125	07ABR	S	12mm	EX	8@125
4053857	BIT BQ 07 -R C25 STG3	7	-R	25mm		Staged
4052946	BIT BQ 07 R C12 EX 8@100	7	R	12mm	EX	8@100
4053256	BIT BQ 07 S C9 5@187	7	S	9mm		5@187
4053055	BIT BQ 07 S C12 6@125	7	S	12mm		6@125
4052674	BIT BQ 07 S C12 8@125	7	S	12mm		8@125
4053150	BIT BQ 07 S C12 6@187	7	S	12mm		6@187
4052685	BIT BQ 07 S C12 EX 8@100	7	S	12mm	EX	8@100
4053805	BIT BQ 07COM -R C25 STG3	07COM	-R	25mm		Staged
4054168	BIT BQ 07COM S C12 8@125	07COM	S	12mm		8@125
4053146	BIT BQ 07COM S C12 EX 8@100	07COM	S	12mm	EX	8@100
4053803	BIT BQ 08ABR -R C25 STG3	08ABR	-R	25mm		Staged
4051890	BIT BQ 08ABR S C9 EX 8@100	08ABR	S	9mm	EX	8@100
4052539	BIT BQ 08ABR S C12 8@125	08ABR	S	12mm		8@125
4053673	BIT BQ 08ABR S C12 6@187	08ABR	S	12mm		6@187

ITEM	DESCRIPTION	SERIES	GAUGE	CROWN HEIGHT	WATERWAY OPTION	WATERWAY SIZES
4053357	BIT BQ 08ABR S C12 8@187	08ABR	S	12mm		8@187
4051655	BIT BQ 08ABR S C12 EX 8@125	08ABR	S	12mm	EX	8@125
4053858	BIT BQ 08 -R C25 STG3	8	-R	25mm		Staged
4050078	BIT BQ 08 R C9 8@125	8	R	9mm		8@125
4050232	BIT BQ 08 R C9 EX 8@125	8	R	9mm	EX	8@125
4053148	BIT BQ 08 S C9 FD 6@187	8	S	9mm	FD	6@187
4052512	BIT BQ 08 S C12 8@125	8	S	12mm		8@125
4053752	BIT BQ 08 S C12 8@187	8	S	12mm		8@187
4052744	BIT BQ 08 S C12 EX 8@100	8	S	12mm	EX	8@100
4052224	BIT BQ 08 S C12 EX 8@125	8	S	12mm	EX	8@125
4052513	BIT BQ 08COM S C12 8@125	08COM	S	12mm		8@125
4052376	BIT BQ 08COM S C12 EX 8@100	08COM	S	12mm	EX	8@100
4053859	BIT BQ 09 -R C25 STG3	9	-R	25mm		Staged
4053304	BIT BQ 09 R C12 6@125	9	R	12mm		6@125
4051509	BIT BQ 09 S C9 EX 8@125	9	S	9mm	EX	8@125
4053492	BIT BQ 09 S C12 6@187	9	S	12mm		6@187
4051791	BIT BQ 09 S C12 8@125	9	S	12mm		8@125
4051650	BIT BQ 09 S C12 EX 8@100	9	S	12mm	EX	8@100
4053193	BIT BQ 09 S C12 EX TW 5@210	9	S	12mm	EX/TW	5@210
4053802	BIT BQ 09COM -R C25 STG3	09COM	-R	25mm		Staged
4053039	BIT BQ 09COM R C9 8@125	09COM	R	9mm		8@125
4052127	BIT BQ 09COM S C12 8@125	09COM	S	12mm		8@125
4054087	BIT BQ 09COM S C12 8@187	09COM	S	12mm		8@187
4054079	BIT BQ 09COM S C12 8@250	09COM	S	12mm		8@250
4052016	BIT BQ 09COM S C12 EX 8@100	09COM	S	12mm	EX	8@100
4050082	BIT BQ 10 R C9 8@125	10	R	9mm		8@125
4051104	BIT BQ 10 R C9 EX 8@125	10	R	9mm	EX	8@125
4051679	BIT BQ 10 S C9 EX 8@125	10	S	9mm	EX	8@125
4052543	BIT BQ 10 S C12 7@125	10	S	12mm		7@125
4052440	BIT BQ 10 S C12 8@125	10	S	12mm		8@125
4052940	BIT BQ 10 S C12 EX 8@100	10	S	12mm	EX	8@100
4054095	BIT BQ 10 S C12 EX 10@100	10	S	12mm	EX	10@100
4053273	BIT BQ 10 S C12 EX TW 6@210	10	S	12mm	EX/TW	6@210
4054080	BIT BQ 10COM -R C25 STG3	10COM	-R	25mm		Staged
4053040	BIT BQ 10COM R C9 8@125	10COM	R	9mm		8@125
4051719	BIT BQ 10COM S C9 EX 8@100	10COM	S	9mm	EX	8@100
4052045	BIT BQ 10COM S C12 8@125	10COM	S	12mm		8@125
4053490	BIT BQ 10COM S C12 EX TW 6@210	10COM	S	12mm	EX/TW	6@210*

BOART LONGYEAR OFFERS COMPLETE CUSTOM DESIGN SERVICES. SEE PAGE 20 FOR DETAILS.

ITEM	DESCRIPTION	SERIES	GAUGE	CROWN HEIGHT	WATERWAY OPTION	WATERWAY SIZES
4053720	BIT BQTK 01 R C6 7@155	1	R	6mm		7@155
4052631	BIT BQTK 02 R C6 7@155	2	R	6mm		7@155
4052330	BIT BQTK 02 S C6 8@125	2	S	6mm		8@125
4052629	BIT BQTK 06 R C9 7@155	6	R	9mm		7@155
4052331	BIT BQTK 06 S C9 8@125	6	S	9mm		8@125
4053109	BIT BQTK 06 S C9 8@155	6	S	9mm		8@155
4051963	BIT BQTK 07ABR S C9 8@125	07ABR	S	9mm		8@125
4053691	BIT BQTK 07ABR S C12 8@155	07ABR	S	12mm		8@155
4052782	BIT BQTK 07 S C12 8@125	7	S	12mm		8@125
4053604	BIT BQTK 07 S C12 7@187	7	S	12mm		7@187
4053841	BIT BQTK 07COM -R C25 STG3	07COM	-R	25mm		Staged
4051552	BIT BQTK 07COM S C9 8@125	07COM	S	9mm		8@125
4053907	BIT BQTK 08ABR -R STG3	08ABR	-R	25mm		Staged
4051254	BIT BQTK 08ABR S C9 8@125	08ABR	S	9mm		8@125
4053693	BIT BQTK 08ABR EC S C12 8@155	08ABR	S	12mm		8@155
4053879	BIT BQTK 08 -R C25 STG3	8	-R	25mm		Staged
4052630	BIT BQTK 08 R C9 7@155	8	R	9mm		7@155
4050420	BIT BQTK 08 S C9 8@125	8	S	9mm		8@125
4053139	BIT BQTK 08 S C9 EX 8@100	8	S	9mm	EX	8@100
4052298	BIT BQTK 08 S C12 8@155	8	S	12mm		8@155
4053600	BIT BQTK 08 S C12 EX 8@125	8	S	12mm	EX	8@125
4053876	BIT BQTK 08COM -R STG3	08COM	-R	25mm		Staged
4051009	BIT BQTK 08COM S C9 7@250	08COM	S	9mm		7@250
4052089	BIT BQTK 08COM S C12 8@125	08COM	S	12mm		8@125
4053870	BIT BQTK 09 -R C25 STG3	9	-R	25mm		Staged
4051688	BIT BQTK 09 S C9 8@125	9	S	9mm		8@125
4053102	BIT BQTK 09 S C12 8@155	9	S	12mm		8@155
4053599	BIT BQTK 09 S C12 EX 8@125	9	S	12mm	EX	8@125
4054094	BIT BQTK 09 S C12 10@100	9	S	12mm	EX	10@100
4053842	BIT BQTK 09COM -R C25 STG3	09COM	-R	25mm		Staged
4053705	BIT BQTK 09COM S C9 EX 7@155	09COM	S	9mm	EX	7@155
4052287	BIT BQTK 09COM S C12 8@125	09COM	S	12mm		8@125
4054074	BIT BQTK 09COM S C12 7@187	09COM	S	12mm		7@187
4054075	BIT BQTK 09COM S C12 7@250	09COM	S	12mm		7@250
4051564	BIT BQTK 10 S C9 8@125	10	S	9mm		8@125
4051949	BIT BQTK 10 S C9 7@155	10	S	9mm	EX	7@155

BQ[®]TK

ITEM	DESCRIPTION	SERIES	GAUGE	CROWN HEIGHT	WATERWAY OPTION	WATERWAY SIZES
4053819	BIT BQTK 10 S C12 8@125	10	S	12mm	EX	8@125
4054093	BIT BQTK 10 S C12 10@100	10	S	12mm	EX	10@100
4053877	BIT BQTK 10COM -R C25 STG3	10COM	-R	25mm		Staged
4051173	BIT BQTK 10COM S C9 7@155	10COM	S	9mm	EX	7@155
4052288	BIT BQTK 10COM S C12 8@125	10COM	S	12mm		8@125

ITEM	DESCRIPTION	SERIES	GAUGE	CROWN HEIGHT	WATERWAY OPTION	WATERWAY SIZES
4050084	BIT NQ 01ABR R C6 7@187	01ABR	R	6mm		7@187
4053324	BIT NQ 01 S C6 7@187	1	S	6mm		7@187
4051619	BIT NQ 01 S C9 TW8@250	1	S	9mm	TW	8@250
4050196	BIT NQ 02 OS 3.032 C6 7@187	2	OS (3.032)	6mm		7@187
4053912	BIT NQ 02 -R C25 STG3	2	-R	25mm		Staged
4050085	BIT NQ 02 R C6 7@187	2	R	6mm		7@187
4050126	BIT NQ 02 S C6 7@187	2	S	6mm		7@187
4051822	BIT NQ 02 S C6 FD 10@125	2	S	6mm	FD	10@125
4051856	BIT NQ 02 S C6 DD 8@250	2	S	6mm	DD	8@250
4053762	BIT NQ 02 S C9 8@155	2	S	9mm		8@155
4051708	BIT NQ 02 S C9 8@250	2	S	9mm		8@250
4053653	BIT NQ 04 R C9 8@250	4	R	9mm		8@250
4050135	BIT NQ 04 S C6 7@187	4	S	6mm		7@187
4053758	BIT NQ 04 S C9 8@250	4	S	9mm		8@250
4053249	BIT NQ 06ABR OS 3.032 C12 8@155	06ABR	OS (3.032)	12mm		8@155
4053638	BIT NQ 06ABR OS 3.032 C12 TW DD 8@250	06ABR	OS (3.032)	12mm	TW/DD	8@250
4053970	BIT NQ 06ABR OS 3.032 C25 STG3	06ABR	OS (3.032)	25mm		Staged
4050090	BIT NQ 06ABR R C9 8@155	06ABR	R	9mm		8@155
4053862	BIT NQ 06ABR -R C25 STG3	06ABR	-R	25mm		Staged
4052627	BIT NQ 06ABR S C12 8@155	06ABR	S	12mm		8@155
4053232	BIT NQ 06ABR S C12 8@250	06ABR	S	12mm		8@250
4050197	BIT NQ 06 OS 3.032 C9 8@155	6	OS (3.032)	9mm		8@155
4053971	BIT NQ 06 OS 3.032 C9 8@187	6	OS (3.032)	9mm		8@187
4050775	BIT NQ 06 OS 3.032 C9 6@313	6	OS (3.032)	9mm		6@313
4054003	BIT NQ 06 -R C25 STG3	6	-R	25mm		Staged
4050089	BIT NQ 06 R C9 8@155	6	R	9mm		8@155
4050176	BIT NQ 06 R C9 EX 8@155	6	R	9mm	EX	8@155
4053656	BIT NQ 06 R C12 8@250	6	R	12mm		8@250
4050139	BIT NQ 06 S C9 8@155	6	S	9mm		8@155
4051712	BIT NQ 06 S C12 8@250	6	S	12mm		8@250
4052632	BIT NQ 06 S C12 8@187	6	S	12mm		8@187
4054041	BIT NQ 06 S C12 TW DD 8@250	6	S	12mm	DD/TW	8@250
4053093	BIT NQ 06 S C12 EX TW 7@250	6	S	12mm	EX/TW	7@250
4054042	BIT NQ 06 S C12 FD 8@187	6	S	12mm	FD	8@187

ITEM	DESCRIPTION	SERIES	GAUGE	CROWN HEIGHT	WATERWAY OPTION	WATERWAY SIZES
4053801	BIT NQ 07ABR -R C25 STG3	07ABR	-R	25mm		Staged
4051166	BIT NQ 07ABR S C9 8@155	07ABR	S	9mm		8@155
4051978	BIT NQ 07ABR S C12 8@155	07ABR	S	12mm		8@155
4053179	BIT NQ 07ABR S C12 10@155	07ABR	S	12mm		10@155
4053579	BIT NQ 07ABR S C12 8@250	07ABR	S	12mm		8@250
4052999	BIT NQ 07ABR S C12 EX 8@125	07ABR	S	12mm	EX	8@125
4053250	BIT NQ 07 OS 3.032 C12 8@155	7	OS (3.032)	12mm		8@155
4053860	BIT NQ 07 OS 3.032 C25 STG3	7	OS (3.032)	25mm		Staged
4053908	BIT NQ 07 R C12 8@155	7	R	12mm		8@155
4052766	BIT NQ 07 R C12 EX 8@155	7	R	12mm	EX	8@155
4053833	BIT NQ 07 -R C25 STG3	7	-R	25mm		Staged
4052993	BIT NQ 07 S C9 FD 6@187	7	S	9mm	FD	6@187
4052998	BIT NQ 07 S C9 EX TW 7@250	7	S	9mm	EX/TW	7@250
4052688	BIT NQ 07 S C12 10@125	7	S	12mm		10@125
4052143	BIT NQ 07 S C12 8@155	7	S	12mm		8@155
4052633	BIT NQ 07 S C12 8@187	7	S	12mm		8@187
4052241	BIT NQ 07 S C12 8@250	7	S	12mm		8@250
4052062	BIT NQ 07 S C12 EX 8@125	7	S	12mm	EX	8@125
4052756	BIT NQ 07 S C12 EX 9@094	7	S	12mm	EX	9@094
4053306	BIT NQ 07 S C12 EX 7@125	7	S	12mm	EX	7@125
4053216	BIT NQ 07 S C12 TW 8@250 *	7	S	12mm	TW	8@250
4053754	BIT NQ 07COM -R C25 STG3	07COM	-R	25mm		Staged
4051797	BIT NQ 07COM S C9 EX 10@094	07COM	S	9mm	EX	10@94
4052144	BIT NQ 07COM S C12 8@155	07COM	S	12mm		8@155
4051403	BIT NQ 07COM S C12 EX 8@125	07COM	S	12mm	EX	8@125
4052200	BIT NQ 07COM S C12 EX 9@094	07COM	S	12mm	EX	9@094
4051743	BIT NQ 08ABR OS 3.032 C12 8@155	08ABR	OS (3.032)	12mm		8@155
4053969	BIT NQ 08ABR OS 3.032 C25 STG3	08ABR	OS (3.032)	25mm		Staged
4050093	BIT NQ 08ABR R C9 8@155	08ABR	R	9mm		8@155
4053834	BIT NQ 08ABR -R C25 STG3	08ABR	-R	25mm		Staged
4052163	BIT NQ 08ABR S C12 8@155	08ABR	S	12mm		8@155
4051653	BIT NQ 08ABR S C12 EX 8@125	08ABR	S	12mm	EX	8@125
4053972	BIT NQ 08 OS 3.032 C9 8@187	8	OS (3.032)	9mm		8@187
4053356	BIT NQ 08 OS 3.032 C12 8@155	8	OS (3.032)	12mm		8@155

NQ[®]**NQ[®]****IMPREGNATED BITS**

ITEM	DESCRIPTION	SERIES	GAUGE	CROWN HEIGHT	WATERWAY OPTION	WATERWAY SIZES
4054098	BIT NQ 08 OS 3.032 C12 EX 8@155	8	OS (3.032)	12mm	EX	8@155
4053947	BIT NQ 08 OS 3.032 C25 STG3	8	OS (3.032)	25mm		Staged
4050333	BIT NQ 08 R C9 EX 8@155	8	R	9mm	EX	8@155
4054179	BIT NQ 08 R C12 8@155	8	R	12mm		8@155
4053847	BIT NQ 08 -R C25 STG3	8	-R	25mm		Staged
4052966	BIT NQ 08 S C9 EX 8@155	8	S	9mm	EX	8@155
4052297	BIT NQ 08 S C9 FD 6@187	8	S	9mm	FD	6@187
4052005	BIT NQ 08 S C9 WD 10@125	8	S	9mm	WD	10@125
4052607	BIT NQ 08 S C12 10@125	8	S	12mm		10@125
4051427	BIT NQ 08 S C12 8@155	8	S	12mm		8@155
4052748	BIT NQ 08 S C12 8@187	8	S	12mm		8@187
4051690	BIT NQ 08 EC S 8@250	8	S	12mm		8@250
4051854	BIT NQ 08 EC S C12 EX 8@125	8	S	12mm	EX	8@125
4053856	BIT NQ 08COM -R C25 STG3	08COM	-R	25mm		Staged
4051406	BIT NQ 08COM S C9 8@155	08COM	S	9mm		8@155
4054019	BIT NQ 08COM S C9 EX 8@125	08COM	S	9mm	EX	8@125
4053537	BIT NQ 08COM S C12 8@250	08COM	S	12mm		8@250
4052377	BIT NQ 08COM S C12 9@094	08COM	S	12mm	EX	9@094
4052662	BIT NQ 09 OS 3.032 C9 8@155	9	OS (3.032)	9mm		8@155
4053973	BIT NQ 09 OS 3.032 C9 8@187	9	OS (3.032)	9mm		8@187
4052597	BIT NQ 09 R C9 8@155	9	R	9mm		8@155
4053835	BIT NQ 09 -R C25 STG3	9	-R	25mm		
4052942	BIT NQ 09 S C12 10@125	9	S	12mm		10@125
4051757	BIT NQ 09 S C12 8@155	9	S	12mm		8@155
4051751	BIT NQ 09 S C12 8@250	9	S	12mm		8@250
4052941	BIT NQ 09 S C12 EX 9@094	9	S	12mm	EX	9@094
4051651	BIT NQ 09 S C12 EX 8@125	9	S	12mm	EX	8@125
4053161	BIT NQ 09 S C12 EX 8@155	9	S	12mm	EX	8@155
4053099	BIT NQ 09 S C12 EX TW 7@250	9	S	12mm	EX/TW	7@250
4053251	BIT NQ 09COM OS 3.032 C9 EX 8@155	09COM	OS (3.032)	9mm	EX	8@155
4053861	BIT NQ 09COM OS 3.032 STG3	09COM	OS (3.032)	25mm		Staged
4052732	BIT NQ 09COM R C9 8@155	09COM	R	9mm		8@155
4052733	BIT NQ 09COM R C9 8@155	09COM	R	9mm	EX	8@155
4052768	BIT NQ 09COM R C12 EX 8@155	09COM	R	12mm	EX	8@155

ITEM	DESCRIPTION	SERIES	GAUGE	CROWN HEIGHT	WATERWAY OPTION	WATERWAY SIZES
4053825	BIT NQ 09COM -R C25 STG3	09COM	-R	25mm		Staged
4052396	BIT NQ 09COM S C12 8@125	09COM	S	12mm		8@125
4052696	BIT NQ 09COM S C12 10@125	09COM	S	12mm		10@125
4052053	BIT NQ 09COM S C12 8@155	09COM	S	12mm		8@155
4053081	BIT NQ 09COM S C12 8@250	09COM	S	12mm		8@250
4052591	BIT NQ 09COM S C12 EX 9@094	09COM	S	12mm	EX	9@094
4052028	BIT NQ 09COM S C12 EX 8@125	09COM	S	12mm	EX	8@125
4053098	BIT NQ 09COM S C12 EX TW 7@250	09COM	S	12mm	EX/TW	7@250
4050401	BIT NQ 10 OS 3.032 8@187	10	OS (3.032)	9mm		8@187
4050095	BIT NQ 10 R C9 8@155	10	R	9mm		8@155
4053832	BIT NQ 10 -R C25 STG3	10	-R	25mm		Staged
4052227	BIT NQ 10 S C12 8@155	10	S	12mm		8@155
4052356	BIT NQ 10 S C12 EX 10@094	10	S	12mm	EX	10@094
4053561	BIT NQ 10 S C12 EX 8@125	10	S	12mm	EX	8@125
4053800	BIT NQ 10COM -R C25 STG3	10COM	-R	25mm		Staged
4052342	BIT NQ 10COM S C9 8@155	10COM	S	9mm		8@155
4052397	BIT NQ 10COM S C12 8@125	10COM	S	12mm		8@125
4053067	BIT NQ 10COM S C12 EX 6@125	10COM	S	12mm	EX	6@125
4052123	BIT NQ 10COM S C12 EX 8@125	10COM	S	12mm	EX	8@125
4053319	BIT NQ 10COM S C12 EX 8@155	10COM	S	12mm	EX	8@155

ITEM	DESCRIPTION	SERIES	GAUGE	CROWN HEIGHT	WATERWAY OPTION	WATERWAY SIZES
4053700	BIT NQTK 01ABR R C6 FD 10@155	01ABR	R	6mm	FD	10@155
4051621	BIT NQTK 01 S C12 TW 8@250	1	S	12mm	TW	8@250
4050182	BIT NQTK 02 R C6 7@187	2	R	6mm		7@187
4050024	BIT NQTK 02 R C6 EX 8@155	2	R	6mm	EX	8@155
4051330	BIT NQTK 02 R C6 FD 10@155	2	R	6mm	FD	10@155
4053822	BIT NQTK 02 R C9 8@155	2	R	9mm		8@155
4053982	BIT NQTK 02 -R C25 STG3	2	-R	25mm		Staged
4050127	BIT NQTK 02 S C6 7@187	2	S	6mm		7@187
4053016	BIT NQTK 02 S C9 8@187*	2	S	9mm		8@187*
4050243	BIT NQTK 04 R C6 7@187	4	R	6mm		7@187
4052888	BIT NQTK 04 S C6 10@125	4	S	6mm		10@125
4052422	BIT NQTK 06ABR S C9 8@155	06ABR	S	9mm		8@155
4050907	BIT NQTK 06 OS 3.032 C9 TW DD 6@250	6	OS (3.032)	9mm	TW/DD	6@250
4053795	BIT NQTK 06 OS 3.032 C12 8@155	6	OS (3.032)	12mm		8@155
4050183	BIT NQTK 06 R C9 8@155	6	R	9mm		8@155
4050025	BIT NQTK 06 R C9 EX 8@155	6	R	9mm	EX	8@155
4053892	BIT NQTK 06 -R C25 STG3	6	-R	25mm		Staged
4053943	BIT NQTK 06 S C9 FD 8@155	6	S	9mm	FD	8@155
4053018	BIT NQTK 06 S C12 8@155	6	S	12mm		8@155
4051433	BIT NQTK 06 S C12 8@187	6	S	12mm		8@187
4053845	BIT NQTK 07ABR -R C25 STG3	07ABR	-R	25mm		Staged
4052555	BIT NQTK 07ABR S C12 8@155	07ABR	S	12mm		8@155
4053064	BIT NQTK 07ABR S C12 TW 10@250	07ABR	S	12mm	TW	10@250
4052812	BIT NQTK 07 OS 3.032 C12 8@155	7	OS (3.032)	12mm		8@155
4053143	BIT NQTK 07 R C9 8@155	7	R	9mm		8@155
4053990	BIT NQTK 07 -R C25 STG3	7	-R	25mm		Staged
4053167	BIT NQTK 07 S C9 8@155	7	S	9mm		8@155
4053944	BIT NQTK 07 S C9 FD 8@155	7	S	9mm	FD	8@155
4053029	BIT NQTK 07 S C12 8@187	7	S	12mm		8@187
4052759	BIT NQTK 07 S C12 EX 8@155	7	S	12mm	EX	8@155
4053837	BIT NQTK 07COM -R C25 STG3	07COM	-R	25mm		Staged
4051569	BIT NQTK 07COM S C9 10@125	07COM	S	9mm		10@125
4053156	BIT NQTK 07COM S C12 8@155	07COM	S	12mm		8@155
4053575	BIT NQTK 07COM S C12 8@187	07COM	S	12mm		8@187
4053840	BIT NQTK 08ABR -R C25 STG3	08ABR	-R	25mm		Staged

ITEM	DESCRIPTION	SERIES	GAUGE	CROWN HEIGHT	WATERWAY OPTION	WATERWAY SIZES
4051432	BIT NQTK 08ABR S C12 8@155	08ABR	S	12mm		8@155
4052813	BIT NQTK 08 OS 3.032 C12 8@155	8	OS (3.032)	12mm		8@155
4050181	BIT NQTK 08 R C9 8@155	8	R	9mm		8@155
4050026	BIT NQTK 08 R C9 EX 8@155	8	R	9mm	EX	8@155
4054017	BIT NQTK 08 -R C25 STG3	8	-R	25mm		Staged
4051037	BIT NQTK 08 S C9 EX 8@155	8	S	9mm	EX	8@155
4053028	BIT NQTK 08 S C12 8@155	8	S	12mm		8@155
4051401	BIT NQTK 08 S C12 EX 8@125	8	S	12mm	EX	8@125
4050013	BIT NQTK 08COM OS 3.032 C9 TW 8@125	08COM	OS (3.032)	9mm	TW	8@125
4050331	BIT NQTK 08COM R C9 8@155	08COM	R	9mm		8@155
4054037	BIT NQTK 08COM -R C25 STG3	08COM	-R	25mm		Staged
4051267	BIT NQTK 08COM S C9 8@155	08COM	S	9mm		8@155
4052499	BIT NQTK 08COM S C9 8@187	08COM	S	9mm		8@187
4053814	BIT NQTK 09 R C12 8@155	9	R	12mm	EX	8@155
4053846	BIT NQTK 09 -R C25 STG3	9	-R	25mm		Staged
4051820	BIT NQTK 09 S C12 8@155	9	S	12mm		8@155
4052647	BIT NQTK 09 S C12 8@250	9	S	12mm		8@250
4052294	BIT NQTK 09 S C12 EX 8@155	9	S	12mm	EX	8@155
4054088	BIT NQTK 09 S C12 EX 10@125	9	S	12mm	EX	10@125
4054181	BIT NQTK 09COM -R C16 STG2	09COM	-R	16mm		Staged
4053893	BIT NQTK 09COM -R C25 STG3	09COM	-R	25mm		Staged
4052118	BIT NQTK 09COM S C12 8@155	09COM	S	12mm		8@155
4052382	BIT NQTK 09COM S C12 8@187	09COM	S	12mm		8@187
4052192	BIT NQTK 09COM S C12 EX 10@094	09COM	S	12mm	EX	10@094
4052305	BIT NQTK 10 OS 3.032 C9 8@155	10	OS (3.032)	9mm		8@155
4050180	BIT NQTK 10 R C9 8@155	10	R	9mm		8@155
4050027	BIT NQTK 10 R C9 EX 8@155	10	R	9mm	EX	8@155
4053995	BIT NQTK 10 -R C25 STG3	10	-R	25mm		Staged
4050123	BIT NQTK 10 S C9 8@155	10	S	9mm		8@155
4052069	BIT NQTK 10 S C9 10@125	10	S	9mm		10@125
4051795	BIT NQTK 10 S C9 EX 10@094	10	S	9mm	EX	10@094
4053138	BIT NQTK 10 S C12 8@187	10	S	12mm		8@187
4054089	BIT NQTK 10 S C12 EX 10@125	10	S	12mm	EX	10@125
4053327	BIT NQTK 10COM R C12 EX 8@155	10COM	R	12mm	EX	8@155

NQ[®]TK

NQ[®]TK

ITEM	DESCRIPTION	SERIES	GAUGE	CROWN HEIGHT	WATERWAY OPTION	WATERWAY SIZES
4052040	BIT NQTK 10COM R C12 10@155	10COM	R	12mm		10@155
4053894	BIT NQTK 10COM -R C25 STG3	10COM	-R	25mm		Staged
4052496	BIT NQTK 10COM S C9 8@187	10COM	S	9mm		8@187
4053019	BIT NQTK 10COM S C12 8@155	10COM	S	12mm		8@155

NQ[®]3

NQ[®]3

ITEM	DESCRIPTION	SERIES	GAUGE	CROWN HEIGHT	WATERWAY OPTION	WATERWAY SIZES
4050651	BIT NQ3 01 R C6 TW 5@188	1	R	6mm	TW	5@188
4053487	BIT NQ3 01 S C6 8@155	1	S	6mm		8@155
4052900	BIT NQ3 02 OS 3.032 C6 6@250	2	OS (3.032)	6mm		6@250
4050178	BIT NQ3 02 R C6 7@187	2	R	6mm		7@187
4051635	BIT NQ3 02 S C6 FD 6@250	2	S	6mm	FD	6@250
4052217	BIT NQ3 02 S C9 8@155	2	S	9mm		8@155
4051386	BIT NQ3 04 R C6 7@187	4	R	6mm		7@187
4051929	BIT NQ3 04 S C6 FD 10@125	4	S	6mm	FD	10@125
4052340	BIT NQ3 04 S C6 DD 6@250	4	S	6mm	DD	6@250
4053646	BIT NQ3 04 S C9 8@187	4	S	9mm		8@187
4052815	BIT NQ3 06 OS 3.032 C9 6@250	6	OS (3.032)	9mm		6@250
4054184	BIT NQ3 06 OS 3.032 C25 STG3	6	OS (3.032)	25mm		Staged
4050336	BIT NQ3 06 R C9 8@155	6	R	9mm		8@155
4053684	BIT NQ3 06 R C12 EX 8@155	6	R	12mm	EX	8@155
4051642	BIT NQ3 06 S C9 10@125	6	S	9mm		10@125
4050143	BIT NQ3 06 S C9 8@155	6	S	9mm		8@155
4052773	BIT NQ3 06 S C9 FD 6@250	6	S	9mm	FD	6@250
4053784	BIT NQ3 06 S C12 8@250	6	S	12mm		8@250
4053637	BIT NQ3 06ABR OS 3.032 C12 DD 6@250	06ABR	OS (3.032)	12mm	DD	6@250
4051684	BIT NQ3 06ABR R C9 TW 8@250	06ABR	R	9mm	TW	8@250
4053956	BIT NQ3 06ABR -R C25 STG3	06ABR	-R	25mm		Staged
4053020	BIT NQ3 06ABR S C12 8@155	06ABR	S	12mm		8@155
4053644	BIT NQ3 07ABR OS 3.032 C12 8@155	07ABR	OS (3.032)	12mm		8@155
4053641	BIT NQ3 07ABR R C9 8@155	07ABR	R	9mm		8@155
4053955	BIT NQ3 07ABR -R C25 STG3	07ABR	-R	25mm		Staged
4053483	BIT NQ3 07ABR S C9 8@250	07ABR	S	9mm		8@250
4053510	BIT NQ3 07ABR S C9 FD 6@250	07ABR	S	9mm	FD	6@250
4052216	BIT NQ3 07ABR S C12 8@155	07ABR	S	12mm		8@155
4053163	BIT NQ3 07ABR S C12 8@187	07ABR	S	12mm		8@187
4054139	BIT NQ3 07 S C9 FD 6@250	7	S	9mm	FD	6@250
4053027	BIT NQ3 07 S C12 8@155	7	S	12mm		8@155
4053076	BIT NQ3 07 S C12 DD 10@125	7	S	12mm	DD	10@125
4052550	BIT NQ3 07COM S C12 EX 8@125	07COM	S	12mm	EX	8@125

BOART LONGYEAR OFFERS COMPLETE CUSTOM DESIGN SERVICES. SEE PAGE 20 FOR DETAILS.

NQ[®]3

NQ[®]3

ITEM	DESCRIPTION	SERIES	GAUGE	CROWN HEIGHT	WATERWAY OPTION	WATERWAY SIZES
4054045	BIT NQ3 08ABR OS 3.032 C25 STG3	08ABR	OS (3.032)	25mm		Staged
4053954	BIT NQ3 08ABR -R C25 STG3	08ABR	-R	25mm		Staged
4053488	BIT NQ3 08ABR S C9 8@250	08ABR	S	9mm		8@250
4053959	BIT NQ3 08ABR S C128@155	08ABR	S	12mm		8@155
4053298	BIT NQ3 08ABR S C12 8@187	08ABR	S	12mm		8@187
4050714	BIT NQ3 08 OS 3.032 C9 8@155	8	OS (3.032)	9mm		8@155
4052814	BIT NQ3 08 OS 3.032 C9 6@250	8	OS (3.032)	9mm		6@250
4052899	BIT NQ3 08 OS 3.032 C9 EX 8@125	8	OS (3.032)	9mm	EX	8@125
4050335	BIT NQ3 08 R C9 8@155	8	R	9mm		8@155
4051515	BIT NQ3 08 R C9 FD 6@250	8	R	9mm	FD	6@250
4053980	BIT NQ3 08 -R C25 STG3	8	-R	25mm		Staged
4051814	BIT NQ3 08 S C9 10@125	8	S	9mm		10@125
4052367	BIT NQ3 08 S C9 8@250	8	S	9mm		8@250
4052237	BIT NQ3 08 S C9 FD 6@250	8	S	9mm	FD	6@250
4051784	BIT NQ3 08COM S C9 DD 8@155	08COM	S	9mm	DD	8@155
4053640	BIT NQ3 09 OS 3.032 C9 8@155	9	OS (3.032)	9mm		8@155
4052252	BIT NQ3 09 R C9 EX 8@155	9	R	9mm	EX	8@155
4053960	BIT NQ3 09 S C12 8@155	9	S	12mm		8@155
4053674	BIT NQ3 09 S C12 8@250	9	S	12mm		8@250
4053178	BIT NQ3 09 S C12 8@125	9	S	12mm	EX	8@125
4052370	BIT NQ3 09COM S C9 FD 6@250	09COM	S	9mm	FD	6@250
4053244	BIT NQ3 09COM S C12 8@155	09COM	S	12mm		8@155
4051025	BIT NQ3 10 OS 3.032 C9 TW 6@250	10	OS (3.032)	9mm	TW	6@250
4051270	BIT NQ3 10 R C9 8@155	10	R	9mm		8@155
4051271	BIT NQ3 10 R C9 EX 8@155	10	R	9mm	EX	8@155
4050962	BIT NQ3 10 S C9 8@155	10	S	9mm		8@155
4051754	BIT NQ3 10 S C9 DD 8@155	10	S	9mm	DD	8@155
4052878	BIT NQ3 10 S C9 EX 8@125	10	S	9mm	EX	8@125
4052494	BIT NQ3 10COM S C9 FD 6@250	10COM	S	9mm	FD	6@250
4052877	BIT NQ3 10COM S C12 EX 8@125	10COM	S	12mm	EX	8@125

NQ[®]TT

NQ[®]TT

ITEM	DESCRIPTION	SERIES	GAUGE	CROWN HEIGHT	WATERWAY OPTION	WATERWAY SIZES
4052519	BIT NQTT 02 R C6 FD 6@250	2	R	6mm	FD	6@250
4051391	BIT NQTT 06 OS 3.032 C9 FD 6@250	6	OS (3.032)	9mm	FD	6@250
4050568	BIT NQTT 06 R C9 FD 6@250	6	R	9mm	FD	6@250
4051451	BIT NQTT 06 S C9 FD 6@250	6	S	9mm	FD	6@250
4051216	BIT NQTT 08ABR S C9 FD 6@250	08ABR	S	9mm	FD	6@250
4053552	BIT NQTT 08 S C9 FD 6@250	8	S	9mm	FD	6@250
4053525	BIT NQTT 09 S C9 FD 6@250	9	S	9mm	FD	6@250

ITEM	DESCRIPTION	SERIES	GAUGE	CROWN HEIGHT	WATERWAY OPTION	WATERWAY SIZES
4050341	BIT HQ 01ABR OS 3.830 C6 TW 8@375	01ABR	OS (3.83)	6mm	TW	8@375
4051138	BIT HQ 01ABR OS 3.895 C6 FD 6@320	01ABR	OS (3.895)	6mm	FD	6@320
4051224	BIT HQ 01ABR OS 3.895 C6 TW DD 4@250	01ABR	OS (3.895)	6mm	TW / DD	4@250
4053478	BIT HQ 01ABR R C6 8@250	01ABR	R	6mm		8@250
4050891	BIT HQ 01ABR S C6 8@250	01ABR	S	6mm		8@250
4050913	BIT HQ 01 S C6 8@250	1	S	6mm		8@250
4051643	BIT HQ 01 S C6 TW 12@250	1	S	9mm	TW	12@250
4051371	BIT HQ 02 OS 3.895 C6 6@625	2	OS (3.895)	6mm		6@625
4050817	BIT HQ 02 OS 3.895 C6 DD 8@250	2	OS (3.895)	6mm	DD	8@250
4054034	BIT HQ 02 OS 3.895 C25 STG3	2	OS (3.895)	25mm		Staged
4050098	BIT HQ 02 R C6 8@250	2	R	6mm		8@250
4053935	BIT HQ 02 -R C25 STG3	2	-R	25mm		Staged
4050351	BIT HQ 02 S C6 8@187	2	S	6mm		8@187
4051812	BIT HQ 02 S C6 FD 12@125	2	S	6mm	FD	12@125*
4051597	BIT HQ 02 S C9 12@125	2	S	9mm		12@125
4052651	BIT HQ 02 S C9 8@250	2	S	9mm		8@250
4051706	BIT HQ 02 S C9 8@313	2	S	9mm		8@313
4053100	BIT HQ 02 S C9 FD 8@250	2	S	9mm	FD	8@250
4052001	BIT HQ 02 S C9 TW 12@375	2	S	9mm	TW	12@375
4054016	BIT HQ 04 OS 3.830 C25 STG3	4	OS (3.83)	25mm		Staged
4050311	BIT HQ 04 R C6 10@125	4	R	6mm		10@125
4053657	BIT HQ 04 R C9 9@250	4	R	9mm		9@250
4051322	BIT HQ 04 S C6 8@250	4	S	6mm		8@250
4053695	BIT HQ 06ABR OS 3.830 C12 8@375	06ABR	OS (3.83)	12mm		8@375
4053269	BIT HQ 06ABR OS 3.895 C12 8@187	06ABR	OS (3.895)	12mm		8@187
4051699	BIT HQ 06ABR OS 3.895 C12 6@375	06ABR	OS (3.895)	12mm		6@375
4051961	BIT HQ 06ABR OS 3.895 C12 TW 6@375	06ABR	OS (3.895)	12mm	TW	6@375
4053824	BIT HQ 06ABR OS 3.895 C25 STG3	06ABR	OS (3.895)	25mm		Staged
4053310	BIT HQ 06ABR OS 3.980 C9 TW 8@313	06ABR	OS (3.98)	9mm	TW	8@313
4053919	BIT HQ 06ABR R C12 8@187	06ABR	R	12mm		8@187
4053866	BIT HQ 06ABR -R C25 STG3	06ABR	-R	25mm		Staged

ITEM	DESCRIPTION	SERIES	GAUGE	CROWN HEIGHT	WATERWAY OPTION	WATERWAY SIZES
4052400	BIT HQ 06ABR S C12 8@187	06ABR	S	12mm		8@187
4052654	BIT HQ 06ABR S C12 8@250	06ABR	S	12mm		8@250
4050256	BIT HQ 06 OS 3.830 C9 8@187	6	OS (3.83)	9mm		8@187
4053776	BIT HQ 06 OS 3.839 C9 12@125	6	OS (3.839)	9mm		12@125
4050194	BIT HQ 06 OS 3.895 C9 8@187	6	OS (3.895)	9mm		8@187
4052753	BIT HQ 06 OS 3.895 C9 8@250	6	OS (3.895)	9mm		8@250
4050816	BIT HQ 06 OS 3.895 C9 DD 8@187	6	OS (3.895)	9mm	DD	8@187
4050192	BIT HQ 06 OS 3.895 C9 EX 8@187	6	OS (3.895)	9mm	EX	8@187
4052736	BIT HQ 06 OS 3.895 C9 FD 6@320	6	OS (3.895)	9mm	FD	6@320
4054182	BIT HQ 06 OS 3.895 C25 STG3	6	OS (3.895)	25mm		Staged
4053528	BIT HQ 06 OS 3.976 C9 8@187	6	OS (3.976)	9mm		8@187
4050138	BIT HQ 06 R C9 8@187	6	R	9mm		8@187
4052751	BIT HQ 06 R C9 8@250	6	R	9mm		8@250
4050168	BIT HQ 06 R C9 EX 8@187	6	R	9mm	EX	8@187
4052740	BIT HQ 06 R C9 FD 6@320	6	R	9mm	FD	6@320
4053658	BIT HQ 06 R C12 9@250	6	R	12mm		9@250
4053917	BIT HQ 06 -R C25 STG3	6	-R	25mm		Staged
4052811	BIT HQ 06 S C9 12@125	6	S	9mm		12@125
4053902	BIT HQ 06 S C9 EX 9@155	6	S	9mm	EX	9@155
4052516	BIT HQ 06 S C9 FD 9@187	6	S	9mm	FD	9@187
4052809	BIT HQ 06 S C12 8@187	6	S	12mm		8@187
4052858	BIT HQ 06 S C12 9@187	6	S	12mm		9@187
4053107	BIT HQ 06 S C12 10@187	6	S	12mm		10@187
4053041	BIT HQ 06 S C12 8@250	6	S	12mm		8@250
4053698	BIT HQ 07ABR OS 3.830 C12	07ABR	OS (3.83)	12mm		8@375
4053903	BIT HQ 07ABR OS 3.830 C25 STG3	07ABR	OS (3.83)	25mm		Staged
4050940	BIT HQ 07ABR OS 3.895 C9 DD 8@187	07ABR	OS (3.895)	9mm	DD	8@187
4054133	BIT HQ 07ABR R C9 8@187	07ABR	R	9mm		8@187
4053864	BIT HQ STG3 07ABR -R C25 STG	07ABR	-R	25mm		Staged
4050892	BIT HQ 07ABR S 8@187	07ABR	S	9mm		8@187
4052882	BIT HQ 07ABR S C12 9@187	07ABR	S	12mm		9@187

ITEM	DESCRIPTION	SERIES	GAUGE	CROWN HEIGHT	WATERWAY OPTION	WATERWAY SIZES
4053961	BIT HQ 07ABR S C12 8@250	07ABR	S	12mm		8@250
4052725	BIT HQ 07 OS 3.830 C9 6@320	7	OS (3.83)	9mm		6@320
4052745	BIT HQ 07 OS 3.895 C9 8@187	7	OS (3.895)	9mm		8@187
4053931	BIT HQ 07 OS 3.895 C25 STG3	7	OS (3.895)	25mm		Staged
4053888	BIT HQ 07 OS 3.976 C9 8@187	7	OS (3.976)	9mm		8@187
4053468	BIT HQ 07 R C12 EX 8@187	7	R	12mm	EX	8@187
4053312	BIT HQ 07 R C9 FD 8@250	7	R	9mm	FD	8@250
4053936	BIT HQ 07 -R C25 STG3	7	-R	25mm		Staged
4052307	BIT HQ 07 S C9 12@125	7	S	9mm		12@125
4053737	BIT HQ 07 S C9 FD 8@250	7	S	9mm	FD	8@250
4052837	BIT HQ 07 S C9 FD TW 8@250	7	S	9mm	TW/FD	8@250
4052916	BIT HQ 07 S C9 WD 9@155	7	S	9mm	WD	9@155
4052399	BIT HQ 07 S C12 8@187	7	S	12mm		8@187
4053583	BIT HQ 07 S C12 8@250	7	S	12mm		8@250
4052944	BIT HQ 07 S C12 8@313	7	S	12mm		8@313
4052792	BIT HQ 07 S C12 EX 12@094	7	S	12mm	EX	12@094
4053112	BIT HQ 07 S C12 EX TW 10@250	7	S	12mm	EX/TW	10@250
4053823	BIT HQ 07COM -R C25 STG3	07COM	-R	25mm		Staged
4051411	BIT HQ 07COM S C9 9@187	07COM	S	9mm		9@187
4052372	BIT HQ 07COM S C12 EX 12@094	07COM	S	12mm	EX	12@094
4052724	BIT HQ 08ABR OS 3.830 C9 6@320	08ABR	OS (3.83)	9mm		6@320
4052729	BIT HQ 08ABR OS 3.895 C9 DD 8@250	08ABR	OS (3.895)	9mm	DD	8@250
4053311	BIT HQ 08ABR OS 3.980 C9 TW 8@313	08ABR	OS (3.98)	9mm	TW	8@313
4053865	BIT HQ STG3 08ABR -R C25 STG3	08ABR	-R	25mm		Staged
4051551	BIT HQ 08ABR S C9 9@187	08ABR	S	9mm		9@187
4052653	BIT HQ 08ABR S C12 8@250	08ABR	S	12mm		8@250
4053162	BIT HQ 08ABR S C12 EX 9@155	08ABR	S	12mm	EX	9@155
4053491	BIT HQ 08 OS 3.830 8@187	8	OS (3.83)	9mm		8@187
4050788	BIT HQ 08 TW OS 3.830 6@375	8	OS (3.83)	9mm	TW	6@375
4053479	BIT HQ 08 OS 3.830 C12 8@250	8	OS (3.83)	12mm		8@250
4052708	BIT HQ 08 OS 3.830 C12 TW 6@375	8	OS(3.83)	12mm	TW	6@375

ITEM	DESCRIPTION	SERIES	GAUGE	CROWN HEIGHT	WATERWAY OPTION	WATERWAY SIZES
4053948	BIT HQ 08 OS 3.830 C25 STG3	8	OS (3.83)	25mm		Staged
4053070	BIT HQ 08 OS 3.839 C9 12@125	8	OS (3.839)	9mm		12@125
4050190	BIT HQ 08 OS 3.895 C9 8@187	8	OS (3.895)	9mm		8@187
4052752	BIT HQ 08 OS 3.895 C9 8@250	8	OS (3.895)	9mm		8@250
4050815	BIT HQ 08 OS 3.895 C9 DD 8@187	8	OS (3.895)	9mm	DD	8@187
4050020	BIT HQ 08 OS 3.895 C9 TW 6@375	8	OS (3.895)	9mm	TW	6@375
4053901	BIT HQ 08 OS 3.895 C25 STG3	8	OS (3.895)	25mm		Staged
4053500	BIT HQ 08 OS 3.967 C9 8@187	8	OS (3.967)	9mm		8@187
4051227	BIT HQ 08 R C9 8@250	8	R	9mm		8@250
4050292	BIT HQ 08 R C9 EX 12@100	8	R	9mm	EX	12@100
4054032	BIT HQ 08 R C12 8@187	8	R	12mm		8@187
4053469	BIT HQ 08 R C12 EX 8@187	8	R	12mm	EX	8@187
4053937	BIT HQ 08 -R C25 STG3	8	-R	25mm		Staged
4051561	BIT HQ 08 S C9 12@125	8	S	9mm		12@125
4050185	BIT HQ 08 S C9 8@187	8	S	9mm		8@187
4053261	BIT HQ 08 S C9 FD 9@187	8	S	9mm	FD	9@187
4053279	BIT HQ 08 S C9 FD 8@250	8	S	9mm	FD	8@250
4053651	BIT HQ 08 WD S 9@155	8	S	9mm	WD	9@155
4051955	BIT HQ 08 S C12 9@155	8	S	12mm		9@155
4052969	BIT HQ 08 S C12 8@250	8	S	12mm		8@250
4053022	BIT HQ 08 S C12 9@187	8	S	12mm		9@187
4050733	BIT HQ 08COM OS 3.895 C9 DD 8@187	08COM	OS (3.895)	9mm	DD	8@187
4050108	BIT HQ 08COM R C9 8@187	08COM	R	9mm		8@187
4053911	BIT HQ 08COM -R C25 STG3	08COM	-R	25mm		Staged
4052535	BIT HQ 08COM S C12 8@187	08COM	S	12mm		8@187
4053240	BIT HQ 09 OS 3.839 C9 12@125	9	OS (3.839)	9mm		12@125
4052769	BIT HQ 09 OS 3.895 C9 DD 8@187	9	OS (3.895)	9mm	DD	8@187
4053513	BIT HQ 09 OS 3.980 C9 8@187	9	OS (3.98)	9mm		8@187
4053724	BIT HQ 09 OS 3.980 C9 TW 8@313	9	OS (3.98)	9mm	TW	8@313
4053283	BIT HQ 09 R C9 8@187	9	R	9mm		8@187
4053470	BIT HQ 09 R C12 EX 8@187	9	R	12mm	EX	8@187

ITEM	DESCRIPTION	SERIES	GAUGE	CROWN HEIGHT	WATERWAY OPTION	WATERWAY SIZES
4053898	BIT HQ 09 -R C25 STG3	9	-R	25mm		Staged
4053060	BIT HQ 09 S C9 12@125	9	S	9mm		12@125
4051951	BIT HQ 09 S C12 9@155	9	S	12mm		9@155
4051926	BIT HQ 09 S C12 8@250	9	S	12mm		8@250
4053023	BIT HQ 09 S C12 9@187	9	S	12mm		9@187
4052716	BIT HQ 09 S C12 EX 12@094	9	S	12mm	EX	12@094
4053113	BIT HQ 09 S C12 EX TW 10@250	9	S	12mm	EX/TW	10@250
4052829	BIT HQ 09COM R C12 12@125	09COM	R	12mm		12@125
4053679	BIT HQ 09COM R C12 TW 6@375	09COM	R	12mm	TW	6@375
4053895	BIT HQ 09COM -R C25 STG3	09COM	-R	25mm		Staged
4052322	BIT HQ 09COM S C12 12@125	09COM	S	12mm		12@125
4053299	BIT HQ 09COM S C12 8@187	09COM	S	12mm		8@187
4052041	BIT HQ 09COM S C12 12@187	09COM	S	12mm		12@187
4053976	BIT HQ 09COM S C12 8@250	09COM	S	12mm		8@250
4052994	BIT HQ 09COM S C12 EX 12@094	09COM	S	12mm	EX	12@094
4050371	BIT HQ 10 OS 3.895 C9 8@187	10	OS (3.895)	9mm		8@187
4050818	BIT HQ 10 OS 3.895 C9 DD 8@187	10	OS (3.895)	9mm	DD	8@187
4053725	BIT HQ 10 OS 3.980 C9 TW 8@313	10	OS (3.98)	9mm	TW	8@313
4050109	BIT HQ 10 R C9 8@187	10	R	9mm		8@187
4050531	BIT HQ 10 R C9 EX 8@187	10	R	9mm	EX	8@187
4053938	BIT HQ 10 -R C25 STG3	10	-R	25mm		Staged
4052211	BIT HQ 10 S C9 9@187	10	S	9mm		9@187
4051168	BIT HQ 10 S C9 EX 12@094	10	S	9mm	EX	12@094
4052652	BIT HQ 10 S C12 8@250	10	S	12mm		8@250
4053200	BIT HQ 10 S C12 EX 9@155	10	S	12mm	EX	9@155
4051360	BIT HQ 10COM OS 3.895 C12 DD 6@320	10COM	OS (3.895)	12mm	DD	6@320
4053680	BIT HQ 10COM R C12 TW 6@375	10COM	R	12mm	TW	6@375
4053896	BIT HQ 10COM -R C25 STG3	10COM	-R	25mm		Staged
4052103	BIT HQ 10COM S C9 8@250	10COM	S	9mm		8@250
4052038	BIT HQ 10COM S C12 12@187	10COM	S	12mm		12@187
4052321	BIT HQ 10COM S C12 12@125	10COM	S	12mm		12@125
4053152	BIT HQ 10COM S C12 EX 12@094	10COM	S	12mm	EX	12@094

ITEM	DESCRIPTION	SERIES	GAUGE	CROWN HEIGHT	WATERWAY OPTION	WATERWAY SIZES
4053352	BIT HQ3 01ABR S C6 8@250	01ABR	S	6mm		8@250
4051980	BIT HQ3 01 S C68@250	1	S	6mm		8@250
4053780	BIT HQ3 02 OS 3.830 C6 8@187	2	OS (3.83)	6mm		8@187
4051194	BIT HQ3 02 OS 3.895 C6 DD 8@187	2	OS (3.895)	6mm	DD	8@187
4050171	BIT HQ3 02 R C6 8@250	2	R	6mm		8@250
4051867	BIT HQ3 02 R C6 TW 6@375	2	R	6mm	TW	6@375
4053999	BIT HQ3 02 -R C25 STG3	2	-R	25mm		Staged
4051937	BIT HQ3 02 S C6 12@125	2	S	6mm		12@125
4050867	BIT HQ3 02 S C6 8@250	2	S	6mm		8@250
4051837	BIT HQ3 02 S C6 12@250	2	S	6mm		12@250
4052207	BIT HQ3 02 S C9 9@187	2	S	9mm		9@187
4053753	BIT HQ3 02 S C9 FD 8@250	2	S	9mm	FD	8@250
4050212	BIT HQ3 04 R C6 8@250	4	R	6mm		8@250
4054056	BIT HQ3 04 -R C25 STG3	4	-R	25mm		Staged
4051931	BIT HQ3 04 S C6 FD 12@125	4	S	6mm	FD	12@125
4050289	BIT HQ3 06ABR TW OS 3.895 6@370	06ABR	OS (3.895)	9mm	TW	6@370
4051983	BIT HQ3 06ABR EC OS 3.895 8@250	06ABR	OS (3.895)	12mm		8@250
4054043	BIT HQ3 06ABR OS 3.895 C25 STG3	06ABR	OS (3.895)	25mm		Staged
4051617	BIT HQ3 06ABR R C9 8@187	06ABR	R	9mm		8@187
4053701	BIT HQ3 06ABR R C9 TW 6@375	06ABR	R	9mm	TW	6@375
4053952	BIT HQ3 06ABR -R C25 STG3	06ABR	-R	25mm		Staged
4053242	BIT HQ3 06ABR S C12 9@187	06ABR	S	12mm		9@187
4053962	BIT HQ3 06ABR S C12 8@250	06ABR	S	12mm		8@250
4053781	BIT HQ3 06 OS 3.830 C9 8@187	6	OS (3.83)	9mm		8@187
4050753	BIT HQ3 06 OS 3.830 C9 DD 8@187	6	OS (3.83)	9mm	DD	8@187
4054050	BIT HQ3 06 OS 3.830 C9 FD 8@250	6	OS (3.83)	9mm	FD	8@250
4050261	BIT HQ3 06 OS 3.830 C9 TW 6@375	6	OS (3.83)	9mm	TW	6@375
4053913	BIT HQ3 06 OS 3.830 C25 STG3	6	OS (3.83)	25mm		Staged
4052816	BIT HQ3 06 OS 3.895 C9 8@250	6	OS (3.895)	9mm		8@250
4052528	BIT HQ3 06 OS 3.895 C9 EX 8@187	6	OS (3.895)	9mm	EX	8@187
4052610	BIT HQ3 06 OS 3.895 C9 DD 8@250	6	OS (3.895)	9mm	DD	8@250

BOART LONGYEAR OFFERS COMPLETE CUSTOM DESIGN SERVICES. SEE PAGE 20 FOR DETAILS.

HQ[®]3

HQ[®]3

ITEM	DESCRIPTION	SERIES	GAUGE	CROWN HEIGHT	WATERWAY OPTION	WATERWAY SIZES
4050172	BIT HQ3 06 R C9 8@187	6	R	9mm		8@187
4050309	BIT HQ3 06 R C9 EX 12@100	6	R	9mm	EX	12@100
4053572	BIT HQ3 06 R C12 EX 8@187	6	R	12mm	EX	8@187
4053169	BIT HQ3 06 S C9 8@250	6	S	9mm		8@250
4051794	BIT HQ3 06 S C9 FD 12@125	6	S	9mm	FD	12@125
4052492	BIT HQ3 06 S C9 FD 8@250	6	S	9mm	FD	8@250
4053110	BIT HQ3 06 S C12 9@187	6	S	12mm		9@187
4054044	BIT HQ3 07ABR OS 3.895 C25 STG3	07ABR	OS (3.895)	25mm		Staged
4053875	BIT HQ3 07ABR -R C25 STG3	07ABR	-R	25mm		Staged
4053927	BIT HQ3 07ABR S C9 FD 8@250 FD	07ABR	S	9mm	FD	8@250
4052218	BIT HQ3 07ABR S C12 9@187	07ABR	S	12mm		9@187
4053963	BIT HQ3 07ABR S C12 8@250	07ABR	S	12mm		8@250
4053905	BIT HQ3 07 OS 3.895 C12 8@187	7	OS (3.895)	12mm		8@187
4052490	BIT HQ3 07 R C9 8@187	7	R	9mm		8@187
4053874	BIT HQ3 07 -R C25 STG3	7	-R	25mm		Staged
4052844	BIT HQ3 07 S C9 8@187	7	S	9mm		8@187
4052443	BIT HQ3 07 S C9 DD 8@187	7	S	9mm	DD	8@187
4052896	BIT HQ3 07 S C9 FD 8@250	7	S	9mm	FD	8@250
4053241	BIT HQ3 07 S C12 9@187	7	S	12mm		9@187
4053852	BIT HQ3 07COM -R C25 STG3	07COM	-R	25mm		Staged
4052690	BIT HQ3 07COM S C9 8@187	07COM	S	9mm		8@187
4053535	BIT HQ3 07COM S C12 EX 9@155	07COM	S	12mm	EX	9@155
4052564	BIT HQ3 07COM S C12 DD 8@187	07COM	S	12mm	DD	8@187
4054192	BIT HQ3 08ABR OS 3.895 C12 DD 8@250	08ABR	OS (3.895)	12mm	DD	8@250
4051133	BIT HQ3 08ABR R C9 8@187	08ABR	R	9mm		8@187
4053702	BIT HQ3 08ABR R C9 TW 6@375	08ABR	R	9mm	TW	6@375
4053914	BIT HQ3 08ABR -R C25 STG3	08ABR	-R	25mm		Staged
4052093	BIT HQ3 08ABR S C9 8@187	08ABR	S	9mm		8@187
4052945	BIT HQ3 08ABR S C9 FD 8@250	08ABR	S	9mm	FD	8@250
4053964	BIT HQ3 08ABR S C12 8@250	08ABR	S	12mm		8@250
4054136	BIT HQ3 08 OS 3.830 C12 4@434	8	OS (3.83)	12mm		4@434
4053998	BIT HQ3 08 OS 3.830 C25 STG3	8	OS (3.83)	25mm		Staged
4051453	BIT HQ3 08 OS 3.895 C9 8@250	8	OS (3.895)	9mm		8@250

HQ[®]3

ITEM	DESCRIPTION	SERIES	GAUGE	CROWN HEIGHT	WATERWAY OPTION	WATERWAY SIZES
4051421	BIT HQ3 08 OS 3.895 C9 DD 8@250	8	OS (3.895)	9mm	DD	8@250
4050258	BIT HQ3 08 OS 3.895 C9 TW 6@375	8	OS (3.895)	9mm	TW	6@375
4052417	BIT HQ3 08 OS 3.895 C9 TW DD 6@375	8	OS (3.895)	9mm	TW/DD	6@375
4050170	BIT HQ3 08 R C9 8@187	8	R	9mm		8@187
4050051	BIT HQ3 08 EX R C9 EX 8@187	8	R	9mm	EX	8@187
4050991	BIT HQ3 08 FD R C9 FD 8@250	8	R	9mm	FD	8@250
4053889	BIT HQ3 08 -R C25 STG3	8	-R	25mm		Staged
4051568	BIT HQ3 08 S C9 FD 12@125	8	S	9mm		12@125
4052427	BIT HQ3 08 S C9 8@187	8	S	9mm		8@187
4052444	BIT HQ3 08 S C9 DD 8@187	8	S	9mm	DD	8@187
4052270	BIT HQ3 08 S C9 EX 12@100	8	S	9mm	EX	12@100
4052336	BIT HQ3 08 S C9 FD 8@250	8	S	9mm	FD	8@250
4050213	BIT HQ3 08COM OS 3.830 C9 8@250	08COM	OS (3.83)	9mm		8@250
4051600	BIT HQ3 08COM S C9 12@125	08COM	S	9mm		12@125
4052428	BIT HQ3 08COM S C9 8@187	08COM	S	9mm		8@187
4052675	BIT HQ3 08COM S C9 FD 8@250	08COM	S	9mm	FD	8@250
4053074	BIT HQ3 09 OS 3.830 C9 8@187	9	OS (3.83)	9mm		8@187
4052642	BIT HQ3 09 R C9 8@187	9	R	9mm		8@187
4053939	BIT HQ3 09 -R C25 STG3	9	-R	25mm		Staged
4052786	BIT HQ3 09 S C9 8@250	9	S	9mm		8@250
4052677	BIT HQ3 09 S C9 FD 12@125	9	S	9mm	FD	12@125
4052676	BIT HQ3 09 S C9 FD 8@250	9	S	9mm	FD	8@250
4053202	BIT HQ3 09 S C12 9@187	9	S	12mm		9@187
4054066	BIT HQ3 09 S C12 8@250	9	S	12mm		8@250
4053643	BIT HQ3 09 S C12 9@155	9	S	12mm	EX	9@155
4052960	BIT HQ3 09COM S C9 EX 9@155	09COM	S	9mm	EX	9@155
4052371	BIT HQ3 09COM S C9 FD 8@250	09COM	S	9mm	FD	8@250
4053243	BIT HQ3 09COM S C12 9@187	09COM	S	12mm		9@187
4053205	BIT HQ3 10 OS 3.830 C9 8@187	10	OS (3.83)	9mm		8@187
4054137	BIT HQ3 10 OS 3.830 C12 4@434	10	OS (3.83)	12mm		4@434
4053981	BIT HQ3 10 OS 3.83 C25 STG3	10	OS (3.83)	25mm		Staged
4050169	BIT HQ3 10 R C9 8@187	10	R	9mm		8@187

BOART LONGYEAR OFFERS COMPLETE CUSTOM DESIGN SERVICES. SEE PAGE 20 FOR DETAILS.

HQ[®]3

HQ[®]3

ITEM	DESCRIPTION	SERIES	GAUGE	CROWN HEIGHT	WATERWAY OPTION	WATERWAY SIZES
4050437	BIT HQ3 10 R C9 EX 8@187	10	R	9mm	EX	8@187
4052335	BIT HQ3 10 S C9 FD 8@250	10	S	9mm	FD	8@250
4053203	BIT HQ3 10 S C12 9@187	10	S	12mm		9@187
4052870	BIT HQ3 10 S C12 EX 9@155	10	S	12mm	EX	9@155
4051715	BIT HQ3 10COM R C9 12@125	10COM	R	9mm		12@125
4052274	BIT HQ3 10COM R C9 EX 8@187	10COM	R	9mm	EX	8@187
4052709	BIT HQ3 10COM S C9 8@250	10COM	S	9mm		8@250
4052196	BIT HQ3 10COM S C9 FD 8@250	10COM	S	9mm	FD	8@250

ITEM	DESCRIPTION	SERIES	GAUGE	CROWN HEIGHT	WATERWAY OPTION	WATERWAY SIZES
4050593	BIT HQTT 01 OS 3.895 C6 FD 8@250	1	OS (3.895)	6mm	FD	8@250
4051200	BIT HQTT 01 R C6 FD 8@250	1	R	6mm	FD	8@250
4051831	BIT HQTT 01 S C6 FD 8@250	1	S	6mm	FD	8@250
4053829	BIT HQTT 02 OS 3.830 C12 EX FD 7@187	2	OS (3.83)	12mm	EX/FD	7@187
4050245	BIT HQTT 02 OS 3.895 C9 FD 6@320	2	OS (3.895)	9mm	FD	6@320
4050539	BIT HQTT 02 R C9 FD 8@250	2	R	9mm	FD	8@250
4052547	BIT HQTT 02 S C9 FD 8@250	2	S	9mm	FD	8@250
4052836	BIT HQTT 02 S C6 FD TW 8@250	2	S	6mm	FD TW	8@250
4053830	BIT HQTT 04 OS 3.830 C12 FD 7@187	4	OS (3.83)	12mm	FD	7@187
4052738	BIT HQTT 04 S C9 FD 8@250	4	S	9mm	FD	8@250
4053828	BIT HQTT 06 OS 3.830 C12 EX FD 7@187	6	OS (3.83)	12mm	EX/FD	7@187
4050203	BIT HQTT 06 OS 3.830 C9 FD 8@250	6	OS (3.83)	9mm	FD	8@250
4050407	BIT HQTT 06 OS 3.895 C9 FD 6@250	6	OS (3.895)	9mm	FD	6@250
4050165	BIT HQTT 06 R C9 FD 8@250	6	R	9mm	FD	8@250
4052565	BIT HQTT 06 S C9 FD 8@250	6	S	9mm	FD	8@250
4053632	BIT HQTT 06 S C9 FD 12@313	6	S	9mm	FD	12@313
4051294	BIT HQTT 07ABR OS 3.830 C9 FD 8@250	07ABR	OS (3.83)	9mm	FD	8@250
4051217	BIT HQTT 07ABR S C9 FD 8@250	07ABR	S	9mm	FD	8@250
4052420	BIT HQTT 07 OS 3.895 C9 FD 6@320	7	OS (3.895)	9mm	FD	6@320
4052566	BIT HQTT 07 S C9 FD 8@250	7	S	9mm	FD	8@250
4052847	BIT HQTT 08ABR OS 3.830 C9 FD 6@320	08ABR	OS (3.83)	9mm	FD	6@320
4051218	BIT HQTT 08ABR S C9 FD 8@250	08ABR	S	9mm	FD	8@250
4051942	BIT HQTT 08 OS 3.830 C9 FD 3@320	8	OS (3.83)	9mm	FD	3@320
4051191	BIT HQTT 08 OS 3.895 C9 FD 6@320	8	OS (3.895)	9mm	FD	6@320
4050489	BIT HQTT 08 R C9 FD 8@250	8	R	9mm	FD	8@250
4051510	BIT HQTT 08 S C9 FD 8@250*	8	S	9mm	FD	8@250
4051678	BIT HQTT 09 S C12 FD 8@250	9	S	12mm	FD	8@250
4053526	BIT HQTT 10 S C9 FD 8@250	10	S	9mm	FD	8@250

BOART LONGYEAR OFFERS COMPLETE CUSTOM DESIGN SERVICES. SEE PAGE 20 FOR DETAILS.

PQ®**PQ®****IMPRREGNATED BITS**

ITEM	DESCRIPTION	SERIES	GAUGE	CROWN HEIGHT	WATERWAY OPTION	WATERWAY SIZES
4053687	BIT PQ 01ABR R C6 10@250	01ABR	R	6mm		10@250
4053670	BIT PQ 01 S C6 FD 12@187	1	S	6mm	FD	12@187
4051208	BIT PQ 02 OS 4.950 C6 10@250	2	OS (4.95)	6mm		10@250
4050296	BIT PQ 02 R C6 10@250	2	R	6mm		10@250
4052474	BIT PQ 02 S C6 12@187	2	S	6mm		12@187
4052800	BIT PQ 02 S C6 10@250	2	S	6mm		10@250
4053671	BIT PQ 02 S C6 FD 12@187	2	S	6mm	FD	12@187
4053406	BIT PQ 02 S C9 12@250	2	S	9mm		12@250
4053545	BIT PQ 04 S C6 10@250	4	S	6mm		10@250
4052599	BIT PQ 06ABR R C9 16@125	06ABR	R	9mm		16@125
4054119	BIT PQ 06ABR S C9 14@125	06ABR	S	9mm		14@125
4053551	BIT PQ 06ABR S C12 10@250	06ABR	S	12mm		10@250
4050879	BIT PQ 06 OS 4.950 C9 8@250	6	OS (4.95)	9mm		8@250
4050305	BIT PQ 06 R C9 16@125	6	R	9mm		16@125
4050915	BIT PQ 06 R C9 EX 12@125	6	R	9mm	EX	12@125
4054177	BIT PQ 06 R C12 10@250	6	R	12mm		10@250
4051984	BIT PQ 06 S C9 14@125	6	S	9mm		14@125
4051615	BIT PQ 06 S C9 12@187	6	S	9mm		12@187
4052801	BIT PQ 06 S C9 10@250	6	S	9mm		10@250
4052974	BIT PQ 07ABR S C12 12@187	07ABR	S	12mm		12@187
4052391	BIT PQ 07 S C9 14@125	7	S	9mm		14@125
4052913	BIT PQ 07 S C9 12@187	7	S	9mm		12@187
4052983	BIT PQ 07 S C12 10@250	7	S	12mm		10@250
4051868	BIT PQ 07COM S C9 14@125	07COM	S	9mm		14@125
4053407	BIT PQ 07COM S C12 EX 14@125	07COM	S	12mm	EX	14@125
4053546	BIT PQ 08ABR S C12 12@187	08ABR	S	12mm		12@187
4053746	BIT PQ 08 OS 4.921 C9 12@187	8	OS (4.921)	9mm		12@187
4051209	BIT PQ 08 OS 4.950 C9 12@187	8	OS (4.95)	9mm		12@187
4050524	BIT PQ 08 R C9 16@125	8	R	9mm		16@125
4053991	BIT PQ 08 R C12 12@187	8	R	12mm		12@187
4053987	BIT PQ 08 -R C25 STG3	8	-R	25mm		Staged
4051586	BIT PQ 08 S C9 14@125	8	S	9mm		14@125
4052802	BIT PQ 08 S C9 10@250	8	S	9mm		10@250
4053550	BIT PQ 08 S C12 12@187	8	S	12mm		12@187
4053992	BIT PQ 09 R C12 12@187	9	R	12mm		12@187

PQ®

PQ®

ITEM	DESCRIPTION	SERIES	GAUGE	CROWN HEIGHT	WATERWAY OPTION	WATERWAY SIZES
4053988	BIT PQ 09 -R C25 STG3	9	-R	25mm		Staged
4052392	BIT PQ 09 S C9 14@125	9	S	9mm		14@125
4053692	BIT PQ 09COM S C12 10@250	09COM	S	12mm		10@250
4050624	BIT PQ 10 R C9 16@125	10	R	9mm		16@125
4052058	BIT PQ 10 S C9 14@125	10	S	9mm		14@125
4051556	BIT PQ 10 S C9 EX 14@125	10	S	9mm	EX	14@125
4053170	BIT PQ 10COM S C9 10@250	10COM	S	9mm		10@250

PQ®3

PQ®3

ITEM	DESCRIPTION	SERIES	GAUGE	CROWN HEIGHT	WATERWAY OPTION	WATERWAY SIZES
4053353	BIT PQ3 01ABR S C6 12@187	01ABR	S	6mm		12@187
4050880	BIT PQ3 01 R C6 10@250	1	R	6mm		10@250
4053155	BIT PQ3 01 S C6 12@187	1	S	6mm		12@187
4050303	BIT PQ3 02 R C6 10@250	2	R	6mm		10@250
4051110	BIT PQ3 02 R C6 10@320	2	R	6mm		10@320
4054008	BIT PQ3 02 -R C25 STG3	2	-R	25mm		Staged
4053986	BIT PQ3 02 S C6 12@187	2	S	6mm		12@187
4052548	BIT PQ3 02 S C6 FD 10@250	2	S	6mm	FD	10@250
4053208	BIT PQ3 02 S C9 12@187	2	S	9mm		12@187
4051263	BIT PQ3 04 R C6 10@250	4	R	6mm		10@250
4052641	BIT PQ3 04 R C6 TW 10@250	4	R	6mm	TW	10@250
4054054	BIT PQ3 04 -R C25 STG3	4	-R	25mm		Staged
4053790	BIT PQ3 04 S C6 FD 10@250	4	S	6mm	FD	10@250
4054190	BIT PQ3 06ABR S C9 FD 10@250	06ABR	S	9mm	FD	10@250
4053965	BIT PQ3 06ABR S C12 10@250	06ABR	S	12mm		10@250
4050491	BIT PQ3 06 R C6 12@125	6	R	9mm		12@125
4052363	BIT PQ3 06 S C6 12@155	6	S	9mm		12@155
4052667	BIT PQ3 06 S C6 FD 10@250	6	S	9mm	FD	10@250
4053209	BIT PQ3 06 S C12 12@187	6	S	12mm		12@187
4053924	BIT PQ3 07ABR S C9 FD 10@250	07ABR	S	9mm	FD	10@250
4053966	BIT PQ3 07ABR S C12 10@250	07ABR	S	12mm		10@250
4054129	BIT PQ3 07 S C9 12@155	7	S	9mm		12@155
4052897	BIT PQ3 07 S C9 FD 10@250	7	S	9mm	FD	10@250
4053210	BIT PQ3 07 S C12 12@187	7	S	12mm		12@187
4053305	BIT PQ3 08ABR S C12 10@250	08ABR	S	12mm		10@250
4050728	BIT PQ3 08 OS 4.950 C9 10@188	8	OS (4.95)	9mm		10@188
4050441	BIT PQ3 08 R C9 16@125	8	R	9mm		16@125
4051111	BIT PQ3 08 R C9 10@320	8	R	9mm		10@320
4054055	BIT PQ3 08 -R C25 STG3	8	-R	25mm		Staged
4052549	BIT PQ3 08 S C9 FD 10@250	8	S	9mm	FD	10@250
4053623	BIT PQ3 08 S C12 12@187	8	S	12mm		12@187
4054188	BIT PQ3 08COM S C9 FD 10@250	08COM	S	9mm	FD	10@250
4051871	BIT PQ3 09 R C9 16@125	9	R	9mm		16@125
4053923	BIT PQ3 09 S C9 FD 10@250	9	S	9mm	FD	10@250

PQ[®]3

PQ[®]3

ITEM	DESCRIPTION	SERIES	GAUGE	CROWN HEIGHT	WATERWAY OPTION	WATERWAY SIZES
4053333	BIT PQ3 09 S C12 10@250	9	S	12mm		10@250
4052774	BIT PQ3 09COM S C9 FD 10@250	9COM	S	9mm	FD	10@250
4051541	BIT PQ3 10 R C9 EX 12@155	10	R	9mm	EX	12@155
4054183	BIT PQ3 10 S C9 10@250	10	S	9mm		10@250
4053543	BIT PQ3 10 S C12 FD 10@250	10	S	12mm	FD	10@250
4052590	BIT PQ3 10COM S C9 12@187	10COM	S	9mm		12@187
4052602	BIT PQ3 10COM S C9 EX 12@155	10COM	S	9mm	EX	12@155
4052743	BIT PQ3 10COM S C9 FD 10@250	10COM	S	9mm	FD	10@250

PQ[®]TT

PQ[®]TT

ITEM	DESCRIPTION	SERIES	GAUGE	CROWN HEIGHT	WATERWAY OPTION	WATERWAY SIZES
4053309	BIT PQTT 02 S C6 FD 10@250	2	S	6mm	FD	10@250
4054259	BIT PQTT 07 S C9 FD 10@250	7	S	9mm	FD	10@250
4053570	BIT PQTT 08 S C9 FD 10@250	8	S	9mm	FD	10@250
4054260	BIT PQTT 09 S C9 FD 10@250	9	S	9mm	FD	10@250
4053571	BIT PQTT 09COM S C9 FD 10@250	9COM	S	9mm	FD	10@250

ADBGM & ATW

ADBGM and ATW

ITEM	DESCRIPTION	SERIES	GAUGE	CROWN HEIGHT	WATERWAY OPTION	WATERWAY SIZES
4053773	BIT AGM 02 S C6 6@125	2	S	6mm		6@125
4053774	BIT AGM 04 S C6 6@125	4	S	6mm		6@125
4052754	BIT AGM 06 S 6@125	6	S	9mm		6@125
4050754	BIT ATW 06 R C9 EX 6@125	6	R	9mm	EX	6@125
4053426	BIT AGM 06 S 8@155	6	S	9mm		8@155
4052407	BIT ATW 07 S 6@125	7	S	9mm		6@125
4052988	BIT ATW 07 EX S 6@125	7	S	9mm	EX	6@125
4054005	BIT ATW 08ABR -R C25 STG3	08ABR	-R	25mm		Staged
4052408	BIT ATW 08 S 6@125	8	S	9mm		6@125
4051738	BIT AGM 08COM S C9 8@094	08COM	S	9mm		8@094
4051676	BIT AGM 08COM S C9 6@125;	08COM	S	9mm		6@125
4054007	BIT ATW 09 -R C25 STG3	9	-R	25mm		Staged
4052755	BIT AGM 09 S C9 6@125	9	S	9mm		6@125
4053827	BIT ATW 09COM S C12 6@125	09COM	S	12mm		6@125
4053481	BIT ATW 10 S C12 6@125	10	S	12mm		6@125

BDBGM & BTW

BDBGM & BTW

ITEM	DESCRIPTION	SERIES	GAUGE	CROWN HEIGHT	WATERWAY OPTION	WATERWAY SIZES
4052596	BIT BDBGM 02 S C6 TW 7@187	2	S	6mm	TW	7@187
4051752	BIT BDBGM 02 S C6 8@125	2	S	6mm		8@125
4052670	BIT BDBGM 04 S C6 8@125	4	S	6mm		8@125
4052595	BIT BDBGM 04 S C6 TW 7@185	4	S	6mm		7@185
4054255	BIT BTW 06 -R C25 STG3;	6	-R	25mm		Staged
4052962	BIT BDBGM 06 S C12 8@125	6	S	12mm		8@125
4054273	BIT BDBGM 07ABR S C12 8@125;	07ABR	S	12mm		8@125
4053121	BIT BDBGM 07 R C12 8@155	7	R	12mm		8@155
4052976	BIT BDBGM 07 S C12 8@125	7	S	12mm		8@125
4051576	BIT BDBGM 07COM S C9 8@125	7COM	S	9mm		8@125
4053904	BIT BTW 08ABR -R C25 STG3	08ABR	-R	25mm		Staged
4052722	BIT BDBGM 08ABR S C12 8@125	8ABR	S	12mm		8@125
4051753	BIT BDBGM 08 S C9 8@125	8	S	9mm		8@125
4053190	BIT BDBGM 08 S C12 8@155	8	S	12mm		8@155
4053482	BIT BDBGM 08 S C12 EX 8@125	8	S	12mm	EX	8@125
4052561	BIT BDBGM 08COM S C12 8@125	08COM	S	12mm		8@125
4051817	BIT BDBGM 09 R C9 8@125	9	R	9mm		8@125
4053122	BIT BDBGM 09 R C12 8@155	9	R	12mm		8@155
4053996	BIT BTW 09 -R C25 STG3	9	-R	25mm		Staged
4052963	BIT BDBGM 09 S C12 8@125	9	S	12mm		8@125
4052295	BIT BDBGM 09 S C12 8@187	9	S	12mm		8@187
4052552	BIT BDBGM 09 S C12 EX 8@125	9	S	12mm	EX	8@125
4054256	BIT BTW 09COM -R C25 STG3;	09COM	-R	25mm		Staged
4052717	BIT BDBGM 09COM S C12 8@125	09COM	S	12mm		8@125
4053339	BIT BDBGM 10 R C12 8@155	10	R	12mm		8@155
4053997	BIT BTW 10 -R C25 STG3	10	-R	25mm		Staged
4051816	BIT BDBGM 10 S C9 EX 8@125	10	S	9mm	EX	8@125
4052964	BIT BDBGM 10 S C12 8@125	10	S	12mm		8@125
4053881	BIT BDBGM 10COM S C12 8@125	10COM	S	12mm		8@125

NDBGM

NDBGM

ITEM	DESCRIPTION	SERIES	GAUGE	CROWN HEIGHT	WATERWAY OPTION	WATERWAY SIZES
4051303	BIT NDBGM 02 R C6 8@155	2	R	6mm		8@155
4052582	BIT NDBGM 02 S C6 8@155	2	S	6mm		8@155
4051302	BIT NDBGM 06 R C9 8@155	6	R	9mm		8@155
4052583	BIT NDBGM 06 S C9 8@155	6	S	9mm		8@155
4052381	BIT NDBGM 06 S C12 8@250	6	S	12mm		8@250
4052731	BIT NDBGM 07 S C9 8@155	7	S	9mm		8@155
4053660	BIT NDBGM 07 S C9 8@270	7	S	9mm		8@270
4053224	BIT NDBGM 07 S C9 EX 8@125	7	S	9mm	EX	8@125
4051388	BIT NDBGM 08ABR OS 3.032 C9 10@125	08ABR	OS (3.032)	9mm		10@125
4052721	BIT NDBGM 08ABR S C12 8@155	08ABR	S	12mm		8@155
4050424	BIT NDBGM 08 OS 3.032 C9 EX 8@155	8	OS (3.032)	9mm	EX	8@155
4050117	BIT NDBGM 08 R C9 8@155	8	R	9mm		8@155
4052326	BIT NDBGM 08 S C9 8@155	8	S	9mm		8@155
4053223	BIT NDBGM 08 S C9 8@125	8	S	9mm	EX	8@125
4051943	BIT NDBGM 09 OS 3.032 C9 10@125	9	OS (3.032)	9mm		10@125
4051952	BIT NDBGM 09 S C12 8@155	9	S	12mm		8@155
4053222	BIT NDBGM 09 S C9 EX 8@125	9	S	9mm	EX	8@125
4052262	BIT NDBGM 09COM S 8@155	09COM	S	9mm		8@155
4052586	BIT NDBGM 10 S C9 8@155	10	S	9mm		8@155

NTW

NTW

ITEM	DESCRIPTION	SERIES	GAUGE	CROWN HEIGHT	WATERWAY OPTION	WATERWAY SIZES
4052859	BIT NTW 02 S C6 8@155	2	S	6mm		8@155
4054057	BIT NTW 04 EC S 8@155	4	S	12mm		8@155
4054068	BIT NTW 06ABR -R C25 STG3	06ABR	-R	25mm		Staged
4054065	BIT NTW 06ABR S C12 8@155	06ABR	S	12mm		8@155
4052851	BIT NTW 06 OS 3.032 C9 8@155	6	OS (3.032)	9mm		8@155
4052845	BIT NTW 06 R C9 8@155	6	R	9mm		8@155
4054058	BIT NTW 06 S C12 8@155	6	S	12mm		8@155
4054069	BIT NTW 06 -R C25 STG 3	6	-R	25mm		staged
4054070	BIT NTW 07 -R C25 STG3	7	-R	25mm		staged
4054059	BIT NTW 07 S C12 8@155	7	S	12mm		8@155
4052874	BIT NTW 07 EX S 8@125	7	S	9mm	EX	8@125
4054254	BIT NTW 08ABR -R C25 STG3	08ABR	-R	25mm		staged
4054285	BIT NTW 08ABR S C12 8@155	08ABR	S	12mm		8@155
4052852	BIT NTW 08 OS 3.032 C9 8@155	8	OS (3.032)	9mm		8@155
4052846	BIT NTW 08 R C9 8@155	8	R	9mm		8@155
4054071	BIT NTW 08 -R C25 STG3	8	-R	25mm		staged
4054060	BIT NTW 08 S C12 8@155	8	S	12mm		8@155
4053511	BIT NTW 08 S C9 EX 8@125	8	S	9mm	EX	8@125
4053844	BIT NTW 09 OS 3.032 C12 EX 8@155	9	OS (3.032)	12mm	EX	8@155
4054063	BIT NTW 09 -R C25 STG3	9	-R	25mm		staged
4054061	BIT NTW 09 S C12 8@155	9	S	12mm		8@155
4052984	BIT NTW 09 S C9 EX 8@125	9	S	9mm	EX	8@125
4054072	BIT NTW 09COM -R C25 STG3	9	-R	25mm		staged
4054067	BIT NTW 09COM S C12 8@155	09COM	S	12mm		8@155
4053527	BIT NTW 09COM S C12 EX 8@125	09COM	S	12mm	EX	8@155
4052507	BIT NTW 10 R C9 8@155	10	R	9mm		8@155
4054073	BIT NTW 10 -R C25 STG3	10	-R	25mm		staged
4054062	BIT NTW 10 S C12 8@155	10	S	12mm		8@155
4054064	BIT NTW 10 S C12 EX 8@155	10	S	12mm	EX	8@155
4052508	BIT NTW 10COM R C9 8@155	10COM	R	9mm		8@155

HDBGM, HTW, HWF, PWF

HDBGM & HTW

ITEM	DESCRIPTION	SERIES	GAUGE	CROWN HEIGHT	WATERWAY OPTION	WATERWAY SIZES
4053043	BIT HTW 02 S C6 9@155	2	S	6mm		9@155
4053189	BIT HTW 04 S 9@155;	4	S	6mm		9@155
4053809	BIT HTW 06ABR S C12 9@155	06ABR	S	12mm		9@155
4052309	BIT HTW 06 S C9 8@250	6	S	9mm		8@250
4053042	BIT HTW 06 S C9 9@155	6	S	9mm		9@155
4053810	BIT HTW 07ABR S C12 9@155	07ABR	S	12mm		9@155
4053212	BIT HTW 08 S C9 9@155	8	S	9mm		9@155
4051466	BIT HTW 08COM S C9 8@250	08COM	S	9mm		8@250
4053071	BIT HTW 09 OS 3.802 C9 8@250	9	OS (3.802)	9mm		8@250
4051998	BIT HTW 09 S C12 9@155	9	S	12mm		9@155
4053811	BIT HTW 09COM S C12 9@155	09COM	S	12mm		9@155
4053072	BIT HTW 10 OS 3.802 C9 8@250	10	OS (3.802)	9mm		8@250
4052906	BIT HTW 10 S C12 9@155;	10	S	12mm		9@155
4052907	BIT HTW 10COM S C12	10COM	S	12mm		9@155

HWF

ITEM	DESCRIPTION	SERIES	GAUGE	CROWN HEIGHT	WATERWAY OPTION	WATERWAY SIZES
4053665	BIT HWF 02 FD S 10@155	2	S	6mm	FD	10@155
4053431	BIT HWF 06 FD S 10@155	6	S	9mm	FD	10@155
4053941	BIT HWF-CL 06 FD S 8@187	6	S	9mm	FD	8@187
4053432	BIT HWF 08 FD S 10@155	8	S	9mm	FD	10@155
4053433	BIT HWF 09 FD S 10@155	9	S	9mm	FD	10@155
4053897	BIT HWF 10 S 10@155	10	S	9mm		10@155

PWF

ITEM	DESCRIPTION	SERIES	GAUGE	CROWN HEIGHT	WATERWAY OPTION	WATERWAY SIZES
4053451	BIT PWF-CL 02 FD S 12@187	2	S	6mm	FD	12@187
4053749	BIT PWF-CL 04 FD S 12@187	4	S	6mm	FD	12@187
4053940	BIT PWF 06 FD S 12@187	6	S	9mm	FD	12@187
4053437	BIT PWF-CL 06 FD S 12@187	6	S	9mm	FD	12@187
4053448	BIT PWF-CL 09 FD S 12@187	7	S	9mm	FD	12@187
4053438	BIT PWF-CL 07 FD S 12@187	9	S	9mm	FD	12@187

BOART LONGYEAR OFFERS COMPLETE CUSTOM DESIGN SERVICES. SEE PAGE 20 FOR DETAILS.

LTK 46

LTK 46

ITEM	DESCRIPTION	SERIES	GAUGE	CROWN HEIGHT	WATERWAY OPTION	WATERWAY SIZES
4051728	BIT LTK46 02 S C6 5@125	2	S	6mm		5@125
4051720	BIT LTK46 06 S C9 5@125	6	S	9mm		5@125
4052546	BIT LTK46 07 S C9 5@125	7	S	9mm		5@125
4052052	BIT LTK46 08ABR S C9 5@125	8ABR	S	9mm		5@125
4051729	BIT LTK46 08 S C9 5@125	8	S	9mm		5@125
4051536	BIT LTK46 08 S C9 6@125	8	S	9mm		6@125
4052737	BIT LTK46 09 S C9 6@125	9	S	9mm		6@125
4053868	BIT LTK46 09COM S C9 6@125	9COM	S	9mm		6@125
4052067	BIT LTK46 10 S C9 6@125	10	S	9mm		6@125

LTK 48

LTK 48

ITEM	DESCRIPTION	SERIES	GAUGE	CROWN HEIGHT	WATERWAY OPTION	WATERWAY SIZES
4052469	BIT LTK48 01ABR R C6 5@155	1ABR	R	6mm		5@155
4052468	BIT LTK48 01 R C6 5@155	1	R	6mm		5@155
4051624	BIT LTK48 02 S C6 5@155	2	S	6mm		5@155
4052626	BIT LTK48 04 R C6 5@155	4	R	6mm		5@155
4052000	BIT LTK48 04 S C6 5@155	4	S	6mm		5@155
4051508	BIT LTK48 06 S C9 6@125	6	S	9mm		6@125
4051323	BIT LTK48 07ABR C9 6@125	7ABR	S	9mm		6@125
4052282	BIT LTK48 07 S C9 6@125	7	S	9mm		6@125
4051525	BIT LTK48 07COM S C9 6@125	7COM	S	9mm		6@125
4052120	BIT LTK48 08ABR S C9 6@125	8ABR	S	9mm		6@125
4050409	BIT LTK48 08 R C9 6@125	8	R	9mm		6@125
4052784	BIT LTK48 08 R C9 TW 6@188	8	R	9mm	TW	6@180
4052283	BIT LTK48 08 S C9 6@125	8	S	9mm		6@125
4051562	BIT LTK48 08COM S C9 6@125	8COM	S	9mm		6@125
4052903	BIT LTK48 08COM S C9 FD 5@155	8COM	S	9mm	FD	5@155
4051869	BIT LTK48 09 S C9 6@125	9	S	9mm		6@125
4051892	BIT LTK48 09COM S C9 6@125	9COM	S	9mm		6@125
4054006	BIT LTK48 09COM S C12 5@125	9COM	S	12mm		5@125
4051709	BIT LTK48 10 S C9 5@125	10	S	9mm		5@125
4052036	BIT LTK48 10 S C9 6@125	10	S	9mm		6@125
4052035	BIT LTK48 10COM S C9 6@125	10COM	S	9mm		6@125

LTK 60

LTK 60

ITEM	DESCRIPTION	SERIES	GAUGE	CROWN HEIGHT	WATERWAY OPTION	WATERWAY SIZES
4053642	BIT LTK60 02 R C6 7@155	2	R	6mm		7@155
4052213	BIT LTK60 06 S C9 8@125	6	S	9mm		8@125
4052220	BIT LTK60 07ABR S C9 8@125	07ABR	S	9mm		8@125
4053164	BIT LTK60 07COM S C9 8@125	07COM	S	9mm		8@125
4053165	BIT LTK60 08ABR S C9 8@125	08ABR	S	9mm		8@125
4050399	BIT LTK60 08 R C9 8@125	8	R	9mm		8@125
4053166	BIT LTK60 08 S C9 8@125	8	S	9mm		8@125
4052432	BIT LTK60 08COM S C9 8@125	08COM	S	9mm		8@125
4052248	BIT LTK60 09 R C9 8@125	9	R	9mm		8@125
4053004	BIT LTK60 09 S C9 8@125	9	S	9mm		8@125
4051896	BIT LTK60 09COM R C9 7@155	09COM	R	9mm		7@155
4052221	BIT LTK60 09COM S C9 8@125	09COM	S	9mm		8@125
4053346	BIT LTK60 09COM S C12 5@155	09COM	S	12mm		5@155
4052017	BIT LTK60 10 R C9 8@125	10	R	9mm		8@125
4052776	BIT LTK60 10 S C9 8@125	10	S	9mm		8@125
4052222	BIT LTK60 10COM S 8@125;	10COM	S	9mm		8@125

H TYPE

H47

ITEM	DESCRIPTION	SERIES	GAUGE	CROWN HEIGHT	WATERWAY OPTION	WATERWAY SIZES
4053703	BIT H47 02 S C6 6@125	2	S	6mm		6@125
4053342	BIT H47 08 S C9 6@125	8	S	9mm		6@125
4053515	BIT H47 09COM S C9 6@125	09COM	S	9mm		6@125
4053514	BIT H47 10 S C9 6@125	10	S	9mm		6@125
4053343	BIT H47 10 S C9 EX 6@125	10	S	9mm	EX	6@125
4053664	BIT H47 10COM S C9 TW 8@250	10COM	S	9mm	TW	8@250
4054267	BIT H47 10UH S C9 EX 6@125;	10UH	S	9mm	EX	6@125

H56

ITEM	DESCRIPTION	SERIES	GAUGE	CROWN HEIGHT	WATERWAY OPTION	WATERWAY SIZES
4053581	BIT H56 02 S C6 8@125	2	S	6mm		8@125
4053134	BIT H56 06 S C9 8@125	6	S	9mm		8@125
4053003	BIT H56 06 S C9 EX 8@100	6	S	9mm	EX	8@100
4053463	BIT H56 07ABR S C9 8@125	07ABR	S	9mm		8@125
4052857	BIT H56 07 S C9 8@125	7	S	9mm		8@125
4053002	BIT H56 07 S C9 EX 8@100	7	S	9mm	EX	8@100
4052865	BIT H56 08 S C9 8@125	8	S	9mm		8@125
4053001	BIT H56 08 S C9 EX 8@100	8	S	9mm	EX	8@100
4052866	BIT H56 09 S C9 8@125	9	S	9mm		8@125
4052872	BIT H56 09 S C9 EX 8@100	9	S	9mm	EX	8@100
4053867	BIT H56 09COM S C9 8@125	09COM	S	9mm		8@125
4052867	BIT H56 10 S C9 8@125	10	S	9mm		8@125
4052873	BIT H56 10 S C9 EX 8@100	10	S	9mm	EX	8@100
4053502	BIT H56/42 08 S C9 8@125	8	S	9mm		8@125
4053734	BIT H56/42 09 S C9 8@125	9		9mm		8@125
4053580	BIT H56/42 10 S C9 8@125	10		9mm		8@125

H66

ITEM	DESCRIPTION	SERIES	GAUGE	CROWN HEIGHT	WATERWAY OPTION	WATERWAY SIZES
4052856	BIT H66 07 S C9 8@125	7	S	9mm		8@125
4053145	BIT H66 07 S C9 EX 8@125	7	S	9mm	EX	8@125
4053118	BIT H66 08 S C9 EX 8@125	8	S	9mm	EX	8@125
4052868	BIT H66 09 S C9 EX 8@125	9	S	9mm	EX	8@125
4053394	BIT H66 10 S C9 8@125;	10	S	9mm		8@125
4052869	BIT H66 10 S C9 EX 8@125	10	S	9mm	EX	8@125
4053395	BIT H66 10COM S C9 8@125	10COM	S	9mm		8@125

BOART LONGYEAR OFFERS COMPLETE CUSTOM DESIGN SERVICES. SEE PAGE 20 FOR DETAILS.

H TYPE

H76

ITEM	DESCRIPTION	SERIES	GAUGE	CROWN HEIGHT	WATERWAY OPTION	WATERWAY SIZES
4054283	BIT H76 04 S C9 8@125;	4	S	9mm		8@125
4053135	BIT H76 06 S C9 8@125	6	S	9mm		8@125
4054284	BIT H76 07 S C9 8@125	7	S	9mm		8@125
4052951	BIT H76 08 S C9 8@125	8	S	9mm		8@125
4052952	BIT H76 09 S C9 8@125	9	S	9mm		8@125
4052921	BIT H76 09 S C9 EX 8@125	9	S	9mm	EX	8@125
4053818	BIT H76 09COM S C9 8@125	09COM	S	9mm		8@125
4053137	BIT H76 10 S C9 8@125	10	S	9mm		8@125
4052920	BIT H76 10 S C9 EX 8@125	10	S	9mm		8@125
4053399	BIT H76 10COM S C9 8@125	10COM	S	9mm		8@125

T2

T2-46

ITEM	DESCRIPTION	SERIES	GAUGE	CROWN HEIGHT	WATERWAY OPTION	WATERWAY SIZES
4053681	BIT T2-46 01ABR S C6 6@125	01ABR	S	6mm		6@125
4053505	BIT T2-46 01 S C6 6@125	1	S	6mm		6@125
4051740	BIT T2-46 02 S C6 6@125	2	S	6mm		6@125
4053506	BIT T2-46 04 S C6 6@125	4	S	6mm		6@125
4053410	BIT T2-46 06 S C9 6@125	6	S	9mm		6@125
4053409	BIT T2-46 08 S C9 6@125	8	S	9mm		6@125
4051660	BIT T2-46 08COM S C9 6@125	08COM	S	9mm		6@125
4053408	BIT T2-46 09 S C9 6@125	9	S	9mm		6@125

T2-56

ITEM	DESCRIPTION	SERIES	GAUGE	CROWN HEIGHT	WATERWAY OPTION	WATERWAY SIZES
4053419	BIT T2-56 01 S C6 8@125	1	S	6mm		8@125
4051874	BIT T2-56 02 S C6 8@125	2	S	6mm		8@125
4053512	BIT T2-56 04 S C6 8@125	4	S	6mm		8@125
4053267	BIT T2-56 06 S C9 8@125	6	S	9mm		8@125
4053268	BIT T2-56 07 S C9 8@125	7	S	9mm		8@125
4051873	BIT T2-56 07COM S C9 8@125	07COM	S	9mm		8@125
4051872	BIT T2-56 08 S C9 8@125	8	S	9mm		8@125
4051662	BIT T2-56 08COM S C9 8@125	08COM	S	9mm		8@125
4053400	BIT T2-56 08COM S C9 EX 7@125	08COM	S	9mm	EX	7@125
4052183	BIT T2-56 09 S C9 8@125	9	S	9mm		8@125
4054004	BIT T2-56 09 S C12 EX 7@125	9	S	12mm	EX	7@125
4053317	BIT T2-56 09COM S C9 8@125	09COM	S	9mm		8@125
4052819	BIT T2-56 10 S C9 8@125	10	S	9mm		8@125
4053149	BIT T2-56 10 S C9 EX 7@125	10	S	9mm	EX	7@125

T2-66

ITEM	DESCRIPTION	SERIES	GAUGE	CROWN HEIGHT	WATERWAY OPTION	WATERWAY SIZES
4053978	BIT T2-66 01 S C6 7@155	1	S	6mm		7@155
4051664	BIT T2-66 02 S C6 7@155	2	S	6mm		7@155
4053382	BIT T2-66 06 S C6 7@155	6	S	9mm		7@155
4053383	BIT T2-66 08 S C6 7@155	8	S	9mm		7@155
4053605	BIT T2-66 09 S C6 7@155	9	S	9mm		7@155
4053384	BIT T2-66 10 S C6 7@155	10	S	9mm		7@155

BOART LONGYEAR OFFERS COMPLETE CUSTOM DESIGN SERVICES. SEE PAGE 20 FOR DETAILS.

T2

T2-76

ITEM	DESCRIPTION	SERIES	GAUGE	CROWN HEIGHT	WATERWAY OPTION	WATERWAY SIZES
4053389	BIT T2-76 01 S C6 7@187	1	S	6mm		7@187
4051665	BIT T2-76 02 S C6 7@187	2	S	6mm		7@187
4053390	BIT T2-76 04 S C6 7@187	4	S	6mm		7@187
4053388	BIT T2-76 06ABR S C9 8@155	06ABR	S	9mm		8@155
4053427	BIT T2-76 06 S C9 8@155	6	S	9mm		8@155
4053791	BIT T2-76 07 S C9 8@155	7	S	9mm		8@155
4053320	BIT T2-76 08 S C9 8@155	8	S	9mm		8@155
4053765	BIT T2-76 08COM S C12 8@155	08COM	S	12mm		8@155
4053266	BIT T2-76 09 S C9 8@155	9	S	9mm		8@155
4053766	BIT T2-76 09COM S C12 8@155	09COM	S	12mm		8@155
4052827	BIT T2-76 10 S C9 8@155	10	S	9mm		8@155
4053767	BIT T2-76 10COM S C12 8@155	10COM	S	12mm		8@155

T2-86

ITEM	DESCRIPTION	SERIES	GAUGE	CROWN HEIGHT	WATERWAY OPTION	WATERWAY SIZES
4053393	BIT T2-86 01ABR S C6 8@155	01ABR	S	6mm		8@155
4053392	BIT T2-86 01 S C6 8@155	1	S	6mm		8@155
4053617	BIT T2-86 02 S C6 5@155	2	S	6mm		5@155
4053330	BIT T2-86 02 S C6 8@155	2	S	6mm		8@155
4053611	BIT T2-86 04 S C6 8@155*	4	S	6mm		8@155*
4053286	BIT T2-86 06 S C9 8@155*	6	S	9mm		8@155*
4053647	BIT T2-86 07ABR S C9 8@155	07ABR	S	9mm		8@155
4053792	BIT T2-86 08 S C9 8@155	8	S	9mm		8@155
4053329	BIT T2-86 09 S C9 8@155	9	S	9mm		8@155
4053820	BIT T2-86 09COM S C9 8@155	09COM	S	9mm		8@155
4053493	BIT T2-86 10 S C9 8@155	10	S	9mm		8@155

T2

T2-101

ITEM	DESCRIPTION	SERIES	GAUGE	CROWN HEIGHT	WATERWAY OPTION	WATERWAY SIZES
4053368	BIT T2-101 01 S C6 8@187	1	S	6mm		8@187
4053336	BIT T2-101 02 S C6 8@187	2	S	6mm		8@187
4053337	BIT T2-101 04 S C6 8@187	4	S	6mm		8@187
4053326	BIT T2-101 06 S C9 8@187	6	S	9mm		8@187
4053652	BIT T2-101 06ABR S C9 8@187	06ABR	S	9mm		8@187
4053648	BIT T2-101 07ABR S C9 8@187	07ABR	S	9mm		8@187
4053365	BIT T2-101 07 S C9 8@187	7	S	9mm		8@187
4053366	BIT T2-101 08 S C9 8@187	8	S	9mm		8@187
4053331	BIT T2-101 09 S C9 8@187	9	S	9mm		8@187
4053367	BIT T2-101 10 S C9 8@187	10	S	9mm		8@187

T6

T6-101

ITEM	DESCRIPTION	SERIES	GAUGE	CROWN HEIGHT	WATERWAY OPTION	WATERWAY SIZES
4053635	BIT T6-101 01ABR S C6 12@155	01ABR	S	6mm		12@155
4053557	BIT T6-101 01 S C6 8@187	1	S	6mm		8@187
4053372	BIT T6-101 02 S C6 8@187	2	S	6mm		8@187
4053373	BIT T6-101 04 S C6 8@187	4	S	6mm		8@187
4053369	BIT T6-101 06 S C9 8@187	6	S	9mm		8@187
4053370	BIT T6-101 06ABR S C9 8@187	06ABR	S	9mm		8@187
4053563	BIT T6-101 07ABR S C9 8@187	07ABR	S	9mm		8@187
4053542	BIT T6-101 07COM S C9 8@187	07COM	S	9mm		8@187
4053371	BIT T6-101 08ABR S C9 8@186	08ABR	S	9mm		8@187
4053385	BIT T6-101 08 S C9 8@187	8	S	9mm		8@187
4053449	BIT T6-101 09 S C9 8@187	9	S	9mm		8@187

T6-116

ITEM	DESCRIPTION	SERIES	GAUGE	CROWN HEIGHT	WATERWAY OPTION	WATERWAY SIZES
4053816	BIT T6-116 01 S C6 12@187	1	S	6mm		12@187
4053334	BIT T6-116 02 S C6 12@187	2	S	6mm		12@187
4053335	BIT T6-116 04 S C6 12@187	4	S	6mm		12@187
4053387	BIT T6-116 06 S C9 12@187	6	S	9mm		12@187
4054082	BIT T6-116 07 S C9 12@187	7	S	9mm		12@187
4053386	BIT T6-116 08 S 12@187	8	S	9mm		12@187
4053686	BIT T6-116 09 S C9 12@187	9	S	9mm		12@187

B TYPE

B-76

ITEM	DESCRIPTION	SERIES	GAUGE	CROWN HEIGHT	WATERWAY OPTION	WATERWAY SIZES
4053534	BIT B76 02 S C6 8@155	2	S	6mm		8@155
4053628	BIT B76 04 S C6 8@155	4	S	6mm		8@155
4053434	BIT B76 06 S C9 8@155	6	S	9mm		8@155
4053435	BIT B76 09 S C9 8@155	9	S	9mm		8@155
4053436	BIT B76 10 S C9 8@155	10	S	9mm		8@155

B-86

ITEM	DESCRIPTION	SERIES	GAUGE	CROWN HEIGHT	WATERWAY OPTION	WATERWAY SIZES
4053553	BIT B86 02 S C6 8@155	2	S	6mm		8@155
4053629	BIT B86 04 S C6 8@155	4	S	6mm		8@155
4053412	BIT B86 06 S C9 8@155	6	S	9mm		8@155
4053413	BIT B86 09 S C9 8@155	9	S	9mm		8@155
4053414	BIT B86 10 S C9 8@155	10	S	9mm		8@155

B-101

ITEM	DESCRIPTION	SERIES	GAUGE	CROWN HEIGHT	WATERWAY OPTION	WATERWAY SIZES
4053349	BIT B101 02 S C6 8@187	2	S	6mm		8@187
4053364	BIT B101 04 S C6 8@187	4	S	6mm		8@187
4053348	BIT B101 06 S C9 8@187	6	S	9mm		8@187
4053362	BIT B101 09 S C9 8@187	9	S	9mm		8@187

B-116

ITEM	DESCRIPTION	SERIES	GAUGE	CROWN HEIGHT	WATERWAY OPTION	WATERWAY SIZES
4053556	BIT B116 01 S C6 12@187	1	S	6mm		12@187
4053380	BIT B116 02 S C6 12@187	2	S	6mm		12@187
4053381	BIT B116 04 S C6 12@187	4	S	6mm		12@187
4053377	BIT B116 06 S C9 12@187	6	S	9mm		12@187
4053379	BIT B116 08 S C9 12@187	8	S	9mm		12@187
4053378	BIT B116 09 S C9 12@187	9	S	9mm		12@187

B TYPE

B-131

ITEM	DESCRIPTION	SERIES	GAUGE	CROWN HEIGHT	WATERWAY OPTION	WATERWAY SIZES
4053549	BIT B131 02 S C6 12@187	2	S	6mm		12@187
4053503	BIT B131 06 S C9 12@187	6	S	9mm		12@187
4053460	BIT B131 07 S C9 12@187	7	S	9mm		12@187

B-146

ITEM	DESCRIPTION	SERIES	GAUGE	CROWN HEIGHT	WATERWAY OPTION	WATERWAY SIZES
4053576	BIT B146 02 S C6 16@187	2	S	6mm		16@187
4053569	BIT B146 06 S C9 16@187	6	S	9mm		16@187
4053596	BIT B146 08 S C9 16@187	8	S	9mm		16@187
4053851	BIT B146 09 S C9 16@187	9	S	9mm		16@187

LONGYEAR® CASING SHOES

CASING SHOES OVERVIEW..... 77

PART NUMBERS 79

CASING SHOES ORDERING DETAILS..... 79
Q® SIZES 80
METRIC SIZES 84



OVERVIEW

Boart Longyear® casing shoes are heavy duty products which can match up to the toughest formations. With the use of very resilient matrix to optimize diamond retention, they will hold up in very abrasive, unfriendly formations.

CASING & ROD SHOES (1)

The casing and rod shoes are threaded to the end of the outer drill string for penetration through overburden. It assists in seating the outer drill string into the bedrock, providing a tight seal for the drilling fluids to return to the surface. A casing shoe can be used to ream the casing downward when advancing a casing string in an existing hole with the rod string still in place.

The casing shoe inside diameter is flush or has clearance to the inside diameter (ID) of the casing which allows free passage of the core barrel through the shoe. Casing shoes are available in standard and oversize diameters.

Casing shoes are available in impregnated, carbide and surface set.

CASING BITS (2)

These are less commonly used and differ from casing shoes in that the inside diameter of the casing bit is smaller. It will not permit the passage of the core barrel due to the overlap of dimensions.

Casing bits are used when deep or difficult overburden is encountered.

CASING ADVANCER SHOES (NOT SHOWN)

The casing advancer shoe is designed much like a typical casing shoe but has an oversized outer diameter which allows for a roller cone to pass through the ID and provides clearance for the extra cuttings generated.

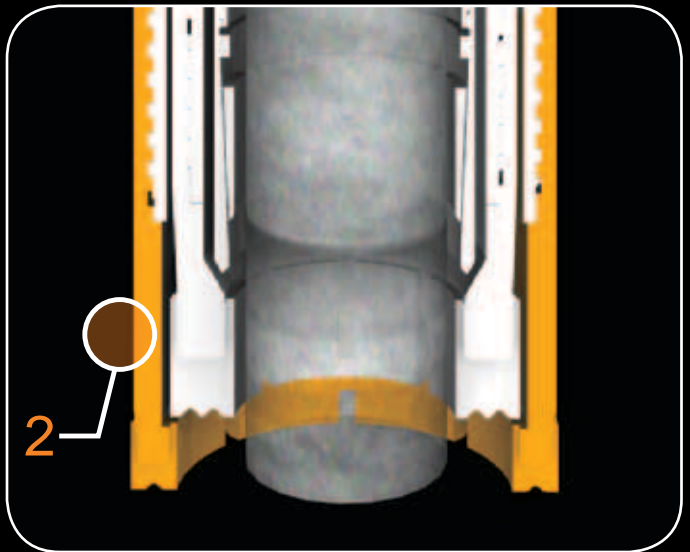
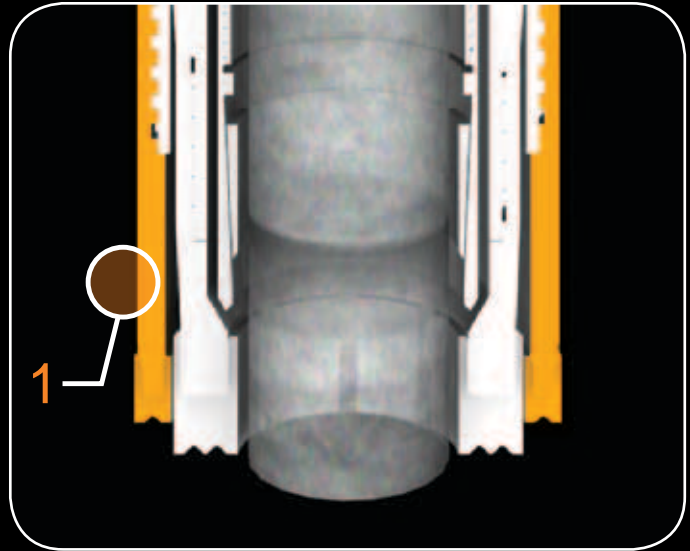

CASING SHOE ORDERING DETAILS

READING A BOART LONGYEAR® CASING SHOE DESCRIPTION:

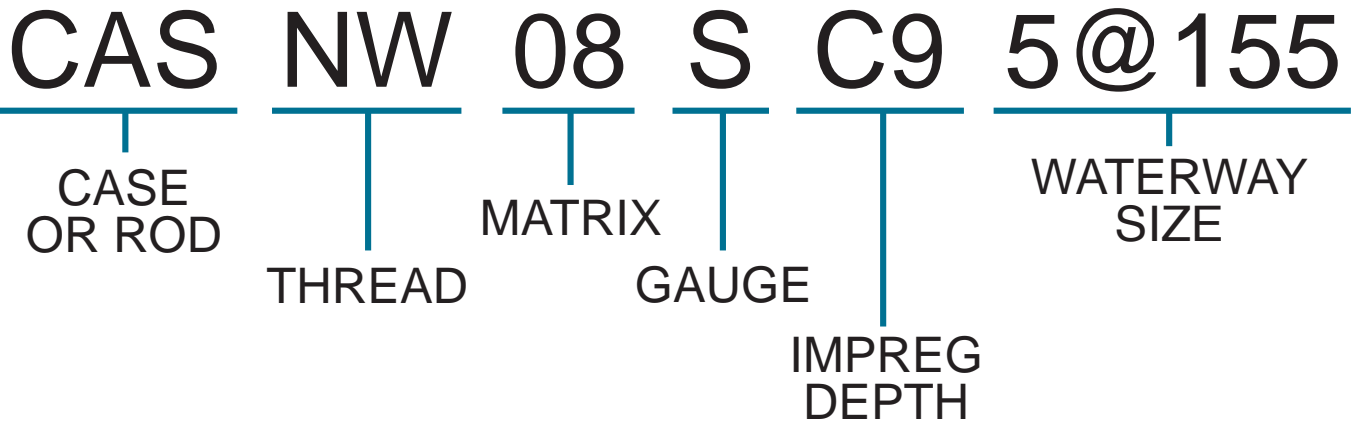

CASE OR ROD

Longyear® casing shoes are available in both casing (CAS) and rod (ROD) shoe configurations.

THREAD

Longyear® bits are available in all standard drilling thread types as well as a number a region-specific sizes.

MATRIX

The Longyear® impregnated diamond bit line has been designed to manage an extremely wide variety of ground conditions. **See page 26 for complete details.**

GAUGE

Longyear® bits are available in three standard OD gauge configurations.

- STANDARD GAUGE (S)
- EQUAL TO REAMING SHELL GAUGE (R)
- OVERSIZED OD (OS, INCHES)

IMPREG DEPTH

Longyear® impregnated diamond bits are currently available in four standard impreg depths of 6mm, 9mm, 12mm and 25mm.

WATERWAY SIZE

Longyear® impregnated casing shoes offer the widest variety of waterway sizes in the industry. The description represents the number of waterways and the waterway size:

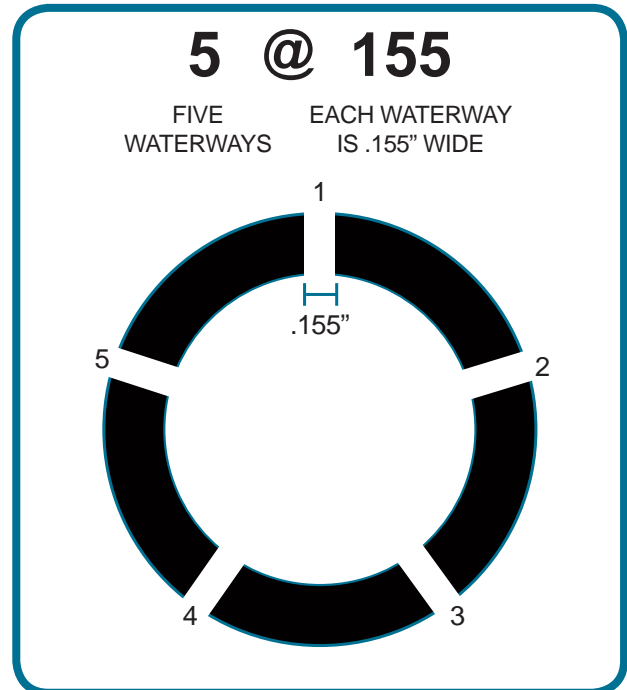

THIS PAGE LEFT INTENTIONALLY BLANK

A,B,N

AW

ITEM	DESCRIPTION	SIZE	SERIES	GAUGE	CROWN HEIGHT	W/W SIZES
4051230	SHOE CAS AW 02 R C3 4@125	AW	2	R	3mm	4@125
4051804	SHOE CAS AW 02 S C3 3@125	AW	2	S	3mm	3@125

BW & BQ®

ITEM	DESCRIPTION	SIZE	SERIES	GAUGE	CROWN HEIGHT	W/W SIZES
4051228	SHOE CAS BW 02 R C3 4@125	BW	2	R	3mm	4@125
4053133	SHOE CAS BW 02 S C3 8@125	BW	2	S	3mm	8@125
4052333	SHOE CAS BW 04 S C3 4@125	BW	4	S	3mm	4@125
4053252	SHOE CAS BW 06 S C3 4@125	BW	6	S	3mm	4@125
4053318	SHOE ROD BQ 02 S C3 4@125	BQ	2	S	3mm	4@125

NW & NQ®/NRQ®

ITEM	DESCRIPTION	SIZE	SERIES	GAUGE	CROWN HEIGHT	W/W SIZES
4053731	SHOE CAS NW 06 S C9 8@155	NW	6	S	9mm	8@155
4050899	SHOE CAS NW 08 S C9 8@155	NW	8	S	9mm	8@155
4051018	SHOE CAS NW 02 OS 3.755 C3 6@250	NW	2	OS (3.755)	3mm	6@250
4051782	SHOE CAS NW 02 OS 3.763 C6 10@125	NW	2	OS (3.763)	6mm	10@125
4050981	SHOE CAS NW 02 R C3 6@125	NW	2	R	3mm	6@125
4051122	SHOE CAS NW 02 S C3 6@125	NW	2	S	3mm	6@125
4101630	SHOE CAS NW 02 C3 OS 3.675 4@125*	NW	02	OS (3.675)	3mm	4@125
4053558	SHOE CAS NW 04 S C3 6@125	NW	4	S	3mm	6@125
4050954	SHOE CAS NW 06 OS 3.755 C9 6@250	NW	6	OS (3.755)	9mm	6@250
4051297	SHOE CAS NW 06 R C3 6@125	NW	6	R	3mm	6@125
4050952	SHOE CAS NW 08 R C9 8@155	NW	8	R	9mm	8@155
4101554	SHOE ROD NQ 02 S 2.813 C3 4@125	NQ	2	S (2.813)	3mm	4@125
4053863	SHOE ROD NQ 04 S 2.850 C5 8@125	NQ	4	S (2.850)	5mm	8@125
4106485	SHOE ROD NQ 09COM S C3 6@125	NQ	09COM	S	3mm	6@125
4053011	SHOE ROD NQ 02 S C3 4@125	NQ	2	S	3mm	4@125
4102880	SHOE ROD NRQ 02 S C3 4@125	NRQ	2	S	3mm	4@125
4053260	SHOE ROD NRQ 09COM S C6 8@125	NRQ	09COM	S	6mm	8@125

BOART LONGYEAR OFFERS COMPLETE CUSTOM DESIGN SERVICES. SEE PAGE 20 FOR DETAILS.

H

HW/HWT & HQ®/HRQ®

ITEM	DESCRIPTION	SIZE	SERIES	GAUGE	CROWN HEIGHT	WW SIZES
4051019	SHOE CAS HW 02 OS 4.765 C3 8@250	HW	2	OS (4.765)	3mm	8@250
4051001	SHOE CAS HW 02 R C3 8@125	HW	2	R	3mm	8@125
4053453	SHOE CAS HW 02 S C6 8@125	HW	2	S	6mm	8@125
4102235	SHOE CAS HW 02CS C6 OS 4.685 6@125*	HW	02CS	OS (4.685)	6mm	6@125
4053454	SHOE CAS HW 04 S C6 8@125	HW	4	S	6mm	8@125
4051724	SHOE CAS HW 06 R C3 8@125	HW	6	R	3mm	8@125
4051320	SHOE CAS HWT 02 R C5 8@125	HWT	2	R	5mm	8@125
4051824	SHOE CAS HWT 02 S C3 8@125	HWT	2	S	3mm	8@125
4053457	SHOE CAS HWT 02 OS 4.765 C9 8@125	HWT	2	OS (4.765)	9mm	8@125
4051774	SHOE CAS HWT 02 OS 4.810 C3 18@125	HWT	2	OS (4.81)	3mm	18@125
4051000	SHOE CAS HWT 02 R C3 8@125	HWT	2	R	3mm	8@125
4052686	SHOE CAS HWT 02 S C9 8@125	HWT	2	S	9mm	8@125
4103356	SHOE CAS HWT 02CS C6 OS 4.685 6@125	HWT	02CS	OS (4.685)	6mm	6@125
4051326	SHOE CAS HWT 06 OS 4.765 C3 8@125	HWT	6	OS (4.765)	3mm	8@125
4053132	SHOE CAS HWT 08 OS 4.765 C6 8@125	HWT	8	OS (4.765)	6mm	8@125
4019077	SHOE ROD HQ 01 S C3 10@125	HQ	1	S	3mm	10@125
4051471	SHOE ROD HQ 02 OS 3.83 C3 10@125	HQ	2	OS (3.83)	3mm	10@125
4050999	SHOE ROD HQ 02 S C3 10@125	HQ	2	S	3mm	10@125
4101350	SHOE ROD HQ 02CS C6 OS 3.74 4@125	HQ	02CS	OS (3.74)	6mm	4@125
4052332	SHOE ROD HQ 04CS S C3 10@125	HQ	4	S	3mm	10@125
4052902	SHOE ROD HQ 06 S C5 10@125	HQ	6	S	5mm	10@125
4053030	SHOE ROD HQ 09COM OS 3.783 C9 12@125	HQ	09COM	OS (3.782)	9mm	12@125
4052154	SHOE ROD HRQ 02 S C3 10@125	HRQ	2	S	3mm	10@125
4053174	SHOE ROD HRQ 02 S C6 6@125	HRQ	2	S	6mm	6@125
4054158	SHOE ROD HRQ 09COM OS 3.782) C9 12@125	HRQ	09COM	OS (3.782)	9mm	12@125

PW/PWT & PQ®

ITEM	DESCRIPTION	SIZE	SERIES	GAUGE	CROWN HEIGHT	W/W SIZES
4051273	SHOE CAS PW 02 OS 5.837 C3 2@125	PW	2	OS (5.837)	3mm	12@125
4053480	SHOE CAS PW 02 R C9 12@125	PW	2	R	9mm	12@125
4053455	SHOE CAS PW 04 R C6 12@125	PW	4	R	6mm	12@125
4052037	SHOE CAS PWT 02 OS 5.790 C2 12@125	PWT	2	OS (5.790)	2mm	12@125
4052355	SHOE CAS PWT 02 R C3 12@125	PWT	2	R	3mm	12@125
4052929	SHOE CAS PWT 06 S C6 12@125	PWT	6	S	6mm	12@125
4051969	SHOE ROD PQ 02 S C3 8@125	PQ	2	S	3mm	8@125

SW

ITEM	DESCRIPTION	SIZE	SERIES	GAUGE	CROWN HEIGHT	W/W SIZES
4051033	SHOE CAS SW 02 R C3 10@125	SW	2	R	3mm	10@125
4051590	SHOE CAS SW 02 S C3 18@125	SW	2	S	3mm	18@125
4053568	SHOE CAS SW 04 S C3 18@125	SW	4	S	3mm	18@125
4053777	SHOE CAS SWT 07 S C6 12@250	SWT	7	S	6mm	12@250

METRIC

METRIC

ITEM	DESCRIPTION	SIZE	SERIES	GAUGE	CROWN HEIGHT	W/W SIZES
4053508	SHOE CAS 56mm 02CS S 8@125	56	02CS	S	3.2mm	8@125
4053619	SHOE CAS 66mm 02 8@125	66	2	S	6mm	8@125
4053794	SHOE CAS 72mm 02 6@187	72	2	S	6mm	6@187
4053706	SHOE CAS 76mm 02 8@125	76	2	S	4.7mm	8@125
4053516	SHOE CAS 86mm 04CS S 10@125	86	04CS	S	3.2mm	10@125
4053578	SHOE CAS 86mm 04CS S 10@125	86	04CS	S	3.2mm	10@125
4053509	SHOE CAS 86mm 02CS S 10@125	86	02CS	S	3.2mm	10@125
4053554	SHOE CAS 86mm 06CS S 10@125	86	06CS	S	3.2mm	10@125
4053404	SHOE CAS 98mm 02CS S 8@155	98	02CS	S	3.2mm	8@155
4053405	SHOE CAS 98mm 06CS S 8@155	98	06CS	S	3.2mm	8@155
4053477	SHOE CAS 113mm 02CS S 10@187	113	02CS	S	3.2mm	10@187
4053682	SHOE CAS 113mm 04 S 10@187	113	4	S	6mm	10@187
4053524	SHOE CAS 116mm 06CS S 8@125	116	06CS	S	3.2mm	8@125
4053602	SHOE CAS 146mm 02CS S 16@155	146	02CS	S	3.2mm	16@155

LONGYEAR® SURFACE-SET BITS

SURFACE-SET OVERVIEW **86**

SURFACE-SET BIT DESIGN OVERVIEW	86
DIAMOND GRADE OVERVIEW	87

PART NUMBERS **88**

SURFACE-SET BIT ORDERING DETAILS.....	88
Q® SIZES	89



SURFACE-SET OVERVIEW

Boart Longyear offers a wide variety of designs for surface set diamond bits. Our selection includes a variety of crown profiles, diamond grades and stone size as well as erosion resistant features. Surface set bits can be very cost effective in soft sedimentary rocks.

CROWN PROFILES

The profile of the bit face or crown is important because it affects drilling speed, hole deviation, and core recovery.

There is a wide choice of profiles for surface set bits which cover all common drilling conditions. As a rule, multistep bits drill fastest but are less robust in hard, broken conditions where round or semi-flat profiles are preferred.



SEMI-ROUND (SRC)

The semi-round is a good general purpose bit, suitable for a wide variety of conditions. It offers good strength in broken conditions.



STEP-TYPE (STP)

The step-type profile provides stabilized drilling capabilities and improves penetration in hard and competent formations. Available in 1-4 step profiles.



PILOT (PC)

The pilot is good for core recovery in soft consolidated formations. This profile offers improved stability and reduced vibrations.



CONCAVE FACE PLUG (CC)

The concave face plug bit is used in general purpose drilling. The profile has a rounded shoulder to a concave face.

PILOT WITH FACE DISCHARGE (PC)

The face discharge crown features extended ports to minimize sample erosion. It increases core recovery in delicate formations.

PILOT PLUG (PC)

The pilot plug bit is used to control hole deviation in softer formations. This profile has two rounded shoulders to a concave face.

DIAMOND GRADE OVERVIEW

DIAMOND CONFIGURATION

Once a crown profile has been identified, DIAMOND GRADE and DIAMOND SIZE are the key factors to choose from to maximize your drill bits performance for life and speed.

DIAMOND GRADE

In selecting the correct diamond grade for the ground condition you are in, the following selection guidelines should be considered:

PREMIUM (PRM): Has the highest percentage of high quality unprocessed natural diamonds.

SPECIAL (SPL): Has a lower percentage of high quality unprocessed natural diamond compared to our premium grade.

SELECT (SEL): The best quality, processed drilling diamonds are suitable for core bits for medium hard to softer formations. These are lower cost diamonds suitable for all general purpose tools.

STANDARD (STD): The lowest cost, partially processed drilling diamonds are normally used in casing tools. These diamonds are suitable in core bits for the softest formations only..

DIAMOND SIZE

Rule of Thumb: The harder the rock, the smaller the diamonds. Small diamonds should not be specified for drilling badly broken ground.

Number of individual stones (or diamonds) is a very important factor in determining how well a bit will cut. Boart Longyear uses mathematical formula to position each and every diamond on a bit to ensure proper overlap with a minimum of diamonds. This keeps the carat weight (and initial bit cost) as low as possible in a balanced design.

Using advanced powder metallurgy technology, coupled with decades of field experience, Boart Longyear has developed a high performance matrix that is suitable for virtually all drill conditions.

BOART LONGYEAR STANDARD DIAMOND SIZES (IN STONES PER CARAT - SPC)

SPC RANGE	DIAMOND SIZE	
6/10	0.098 in	2.49 mm
10/15	0.085 in	2.16 mm
15/25	0.071 in	1.80 mm
25/35	0.063 in	1.560 mm
35/45	0.058 in	1.47 mm
45/55	0.054 in	1.37 mm
55/70	0.048 in	1.22 mm
70/90	0.044 in	1.12 mm
90/100	0.042 in	1.07 mm
110/130	0.040	1.02 mm

SURFACE-SET ORDERING DETAILS

READING A LONGYEAR® SURFACE-SET DIAMOND BIT DESCRIPTION:

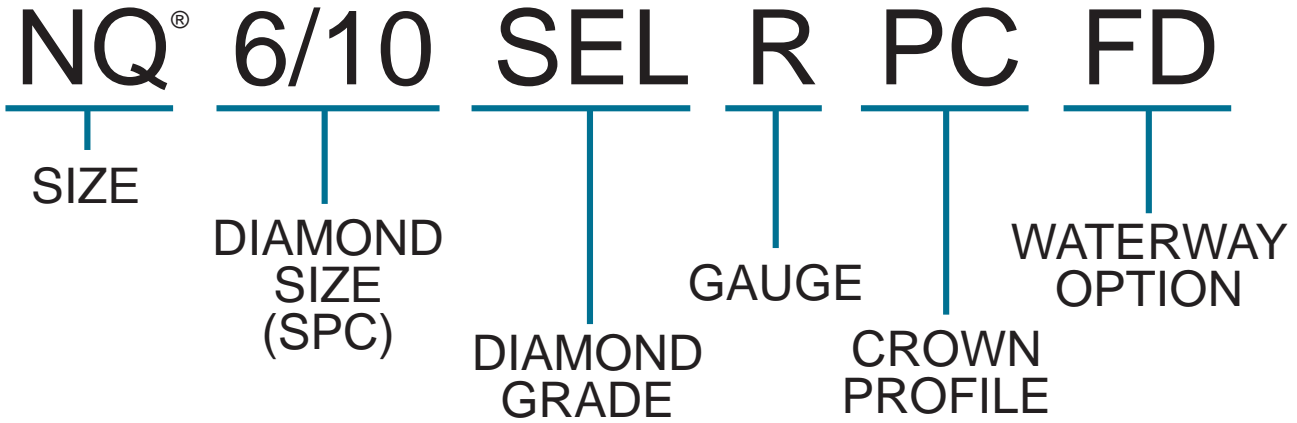

SIZE

Longyear® bits are available in all standard drilling sizes as well as a number a region-specific sizes.

DIAMOND SIZE

Longyear® surface-set diamond bits are available in stone-per-carat configurations ranging for 6/10 to 110/130 SPC. **Please see page 87 for complete details.**

DIAMOND GRADE

Once a crown profile and diamond size has been identified, DIAMOND GRADE is a key factor for maximizing your drill bit performance, life and speed. **Please see page 87 for complete details.**

GAUGE

Longyear® bits are available in four standard gauge configurations.

- STANDARD GAUGE (S)
- EQUAL TO REAMING SHELL GAUGE (R)
- OVERSIZED OD (OS, INCHES)

CROWN PROFILE

Longyear® surface-set diamond bits are available in a wide variety of crown profiles. **Please see page 86 for complete details.**

WATERWAY OPTION

Where applicable, waterway options will be identified here.

- SPIRAL (TW)
- DOUBLE ANGLE (DA)
- FACE DISCHARGE (FD)

E

ITEM	DESCRIPTION	DIAMOND SIZE	DIAMOND GRADE	TOTAL DIAMOND	GAUGE	CROWN PROFILE	W/W OPTION	OTHER
3EPT75/2	BIT PLUG EW R/P 25/35 SEL 11CT R PC	25/35	SEL	11.00CT	R	PC		
3EET75/1	BIT PLUG EWG 25/35 SEL 11CT R CC	25/35	SEL	11.00CT	R	CC		
3EET75/6	BIT PLUG EWG 25/35 SEL 12CT R PC	25/35	SEL	12.25CT	R	PC		
CEET75/1	BIT PLUG EWG 25/35 SEL 15CT OS 1.750 PC	25/35	SEL	14.75CT	OS (1.750)	PC		
3EET65/3	BIT PLUG EWG 35/45 SEL 11CT R PC	35/45	SEL	10.50CT	R	PC		

AQ®

ITEM	DESCRIPTION	DIAMOND SIZE	DIAMOND GRADE	TOTAL DIAMOND	GAUGE	CROWN PROFILE	W/W OPTION	OTHER
1AQB71/1	BIT AQ 25/35 PREM 11CT R SRC	25/35	PREM	11.00CT	R	SRC		
1AQ371/5	BIT AQ 45/55 PREM 10CT R 3STP	45/55	PREM	9.50CT	R	3STP		
1AQ371/6	BIT AQ 45/55 PREM 10CT R 4STP	45/55	PREM	9.75CT	R	4STP		
3AQT65/1	BIT PLUG AQ 35/45 SEL 14CT R PC	35/45	SEL	14.00 CT	R	PC		
3AQT63/1	BIT PLUG AQ R/B 35/45 SPC 14CT R PC	35/45	SPL	14.00CT	R	PC		
CAPT95/2	BIT PLUG AW R/P 6/10 SEL 36CT OS 2.250 PC	6/10	SEL	36.25CT	OS (2.250)	PC		
CAPT85/2	BIT PLUG AW R/P 15/25 SEL 23CT OS 2.000 CC	15/25	SEL	23.25CT	OS (2.000)	CC		
CAPT85/4	BIT PLUG AW R/P 15/25 SEL 33CT OS 2.250 PC	15/25	SEL	33.25CT	OS (2.250)	PC		
3APT75/4	BIT PLUG AW R/P 25/35 SEL 17CT S PC	25/35	SEL	16.50CT	S	PC		
CAPT65/1	BIT PLUG AW R/B 35/45 SEL 16CT OS 2.000 CC	35/45	SEL	16.00CT	OS (2.000)	CC		
CAPT65/2	BIT PLUG AW R/P 35/45 SEL 21CT OS 2.360 CC	35/45	SEL	21.00CT	OS (2.360)	CC		
CAPT65/3	BIT PLUG AW R/P 35/45 SEL 24CT OS 2.500 CC	35/45	SEL	23.50CT	OS (2.500)	CC		
3AET85/2	BIT PLUG AWG 15/25 SEL 18CT R CC	15/25	SEL	18.00CT	R	CC		
3AET65/1	BIT PLUG AWG 35/45 SEL 14CT R PC	35/45	SEL	14.00CT	R	PC		
3AOT95/1	BIT PLUG AWJ R/B 10/15 SEL 20CT R PC	10/15	SEL	20.00CT	R	PC		
CAOT85/1	BIT PLUG AWJ R/B 15/25 SEL 26CT OS 2.000 PC	15/25	SEL	26.25CT	OS (2.000)	PC		
3AOT75/1	BIT PLUG AWJ R/B 25/35 SEL 16CT R PC	25/35	SEL	16.00CT	R	PC		

BOART LONGYEAR OFFERS COMPLETE CUSTOM DESIGN SERVICES. SEE PAGE 20 FOR DETAILS.

ITEM	DESCRIPTION	DIAMOND SIZE	DIAMOND GRADE	TOTAL DIAMOND	GAUGE	CROWN PROFILE	W/W OPTION	OTHER
2BQB95/1	BIT BQ 6/10 SEL 19CT S SRC	6/10	SEL	19.00CT	S	SRC		
4060197	BIT BQ 15/25 SEL 15CT S 2STP	15/25	SEL	14.75CT	S	2 STP		
1BQ383/1	BIT BQ 25/35 SPL 18CT R 3STP	25/35	SPL	18.00CT	R	3 STP		
1BQB65/1	BIT BQ 35/45 SEL 12CT R SRC	35/45	SEL	11.75CT	R	SRC		
2BQB65/1	BIT BQ 35/45 SEL 12CT S SRC	35/45	SEL	11.75CT	S	SRC		
2BQ365/3	BIT BQ 35/45 SEL 12CT S 3STP	35/45	SEL	12.00CT	S	3 STP		
1BQ385/2	BIT BQ 35/45 SEL 12CT R 3STP	35/45	SEL	12.25CT	R	3 STP		
4060199	BIT BQ 35/45 SEL 13CT S 4STP	35/45	SEL	12.75CT	S	4 STP		
1BQB45/1	BIT BQ 55/70 SEL 10CT R SRC	55/70	SEL	9.50CT	R	SRC		
4060195	BIT BQ 55/70 SEL 11CT S 7STP	55/70	SEL	10.75CT	S	7 STP		
4060225	BIT BQ 55/70 SPL 17CT R 7STP	55/70	SPL	17.00CT	R	7 STP		
1BQ553/2	BIT BQ 70/90 SPL 11CT R 5STP	70/90	SPL	10.50CT	R	5 STP		
3BQT55/1	BIT PLUG BQ 45/55 SEL 15CT R PC	45/55	SEL	14.50CT	R	PC		
3BQT45/1	BIT PLUG BQ 55/70 SEL 10CT R CC	55/70	SEL	10.00CT	R	CC		
3BRT85/1	BIT PLUG BQ R/B 15/25 SEL 20CT R CC	15/25	SEL	20.00CT	R	CC		
3BRT65/1	BIT PLUG BQ R/B 35/45 SEL 14CT S CC	35/45	SEL	14.25CT	S	CC		
3BYT85/1	BIT PLUG BQTK 15/25 SEL 21CT R CC	15/25	SEL	20.75CT	R	CC		
CBST85/1	BIT PLUG BWG 15/25 SEL 25CT OS 2.560 CC	15/25	SEL	25.00CT	OS(2.560)	CC		

ITEM	DESCRIPTION	DIAMOND SIZE	DIAMOND GRADE	TOTAL DIAMOND	GAUGE	CROWN PROFILE	W/W OPTION	OTHER
1NQF95/2	BIT NQ 6/10 SEL 32CT R PC FD	6/10	SEL	32.00CT	R	PC	FD	
1NQW93/4	BIT NQ 6/10 SPL 27CT R SRC	6/10	SPL	26.50CT	R	SRC		
1NQW93/6	BIT NQ 6/10 SPL 27CT R SRC	6/10	SPL	26.50CT	R	SRC		
1NQB93/3	BIT NQ 6/10 SPL 33CT R SRC	6/10	SPL	32.50CT	R	SRC		
1NQB95/2	BIT NQ 10/15 SEL 22CT R SRC SW	10/15	SEL	22.00CT	R	SRC	SW	
2NQ395/1	BIT NQ 10/15 SEL 26CT S 3STP	10/15	SEL	25.75CT	S	3STP		
1NYB95/5	BIT NQ 10/15 SEL 26CT R SRC SW	10/15	SEL	26.00CT	R	SRC	SW	
1NQW93/2	BIT NQ 10/15 SPL 22CT R SRC	10/15	SPL	22.00CT	R	SRC		
1NQW93/3	BIT NQ 10/15 SPL 22CT R SRC	10/15	SPL	22.00CT	R	SRC		
ANQW93/1	BIT NQ 10/15 SPL 24CT OS 3.032 SRC	10/15	SPL	23.50CT	OS (3.032)	SRC		
4060176	BIT NQ 15/25 SEL 26CT S 2STP	15/25	SEL	25.50CT	S	2 STP		
4106130	BIT NQ 15/25 SEL 27CT S 5STP	15/25	SEL	27.00CT	S	5 STP		
1NQB75/3	BIT NQ 25/35 SEL 15CT R SRC	25/35	SEL	14.50CT	R	SRC		
4019181	BIT NQ 25/35 SEL 16CT S PC FD	25/35	SEL	15.57CT	S	PC	FD	
2NQF75/1	BIT NQ 25/35 SEL 18CT S PC FD	25/35	SEL	17.75CT	S	PC	FD	
2NQB75/4	BIT NQ 25/35 SEL 19CT S SRC	25/35	SEL	19.00CT	S	SRC		
1NQF75/2	BIT NQ 25/35 SEL 21CT R PC R	25/35	SEL	20.50CT	R	PC		REIN-FORCED WWS
1NQF75/1	BIT NQ 25/35 SEL 27CT R PC FD	25/35	SEL	27.00CT	R	PC	FD	
4106275	BIT NQ 25/35 SPL 23CT S 4STP FD DA	25/35	SPL	23.00CT	S	4 STP	FD, DA	
ANQ483/4	BIT NQ 25/35 SPL 24CT OS 3.032 4STP	25/35	SPL	24.25CT	OS (3.032)	4 STP		
1NQ483/6	BIT NQ 25/35 SPL 25CT R 4STP	25/35	SPL	24.75CT	R	4 STP		
4018418	BIT NQ 35/45 SEL 17CT S SRC	35/45	SEL	17.00CT	S	SRC		

BOART LONGYEAR OFFERS COMPLETE CUSTOM DESIGN SERVICES. SEE PAGE 20 FOR DETAILS.

ITEM	DESCRIPTION	DIAMOND SIZE	DIAMOND GRADE	TOTAL DIAMOND	GAUGE	CROWN PROFILE	W/W OPTION	OTHER
4018810	BIT NQ 35/45 SEL 17CT S 3STP	35/45	SEL	17.25CT	S	3 STP		
2NQ465/1	BIT NQ 35/45 SEL 20CT S 4STP	35/45	SEL	19.50CT	S	4 STP		
1NQ475/1	BIT NQ 35/45 SEL 20CT R 4STP	35/45	SEL	20.25CT	R	4 STP		
1NQ365/6	BIT NQ 45/55 SEL 16CT R 3STP	45/55	SEL	16.25CT	R	3 STP		
2NQ365/1	BIT NQ 45/55 SEL 19CT S 3STP	45/55	SEL	18.75CT	S	3 STP		
2NQ355/1	BIT NQ 45/55 SEL 20CT S 3STP	45/55	SEL	20.00CT	S	3 STP		
2NQF45/1	BIT NQ 55/70 SEL 13CT S PC	55/70	SEL	12.50CT	S	PC		
2NQB45/1	BIT NQ 55/70 SEL 15CT S SRC	55/70	SEL	15.00CT	S	SRC		
1NQ343/1	BIT NQ 55/70 SPL 15CT R 3STP	55/70	SPL	15.00CT	R	3 STP		
4060193	BIT NQ 55/70 SEL 17CT S 7STP	55/70	SEL	16.50CT	S	7 STP		
1NQ333/1	BIT NQ 70/90 SPL 13CT R 3STP	70/90	SPL	12.50CT	R	3 STP		
4019372	BIT NQ 70/90 SEL 13CT S SRC	70/90	SEL	13.25CT	S	SRC		
4105510	BIT PLUG N R/P 35/55 SEL 35CT S CC	35/55	SEL	34.75CT	S	CC		
3NQT75/1	BIT PLUG NQ 25/35 SEL 31CT R CC	25/35	SEL	31.00CT	R	CC		
3NQT53/1	BIT PLUG NQ 45/55 SPC 28CT S CC	45/55	SPL	27.50CT	S	CC		
3NRT95/1	BIT PLUG NQ R/B 6/10 SEL 48CT R CC	6/10	SEL	48.00CT	R	CC		
3NRT75/3	BIT PLUG NQ R/B 25/35 SEL 29CT R CC	25/35	SEL	28.75CT	R	CC		
3N0T85/1	BIT PLUG NWJ R/B 15/25 SEL 35CT R CC	15/25	SEL	35.00CT	R	CC		

NQ[®]2

ITEM	DESCRIPTION	DIAMOND SIZE	DIAMOND GRADE	TOTAL DIAMOND	GAUGE	CROWN PROFILE	W/W OPTION	OTHER
1NYB95/3	BIT NQ2 6/10 SEL 32CT R SRC	6/10	SEL	31.50CT	R	SRC		
1NYW93/2	BIT NQ2 6/10 SPL 22CT R SRC	6/10	SPL	21.75CT	R	SRC		
1NYW91/1	BIT NQ2 6/10 PREM 22CT R SRC	6/10	PREM	21.75CT	R	SRC		
1NYB95/2	BIT NQ2 10/15 SEL 24CT R SRC	10/15	SEL	24.25CT	R	SRC		
1NYF95/2	BIT NQ2 10/15 SEL 26CT R PC	10/15	SEL	25.75CT	R	PC		
1NYW93/1	BIT NQ2 10/15 SPL 20CT R SRC	10/15	SPL	20.25CT	R	SRC		
1NYB93/6	BIT NQ2 10/15 SPL 26CT R SRC	10/15	SPL	26.00CT	R	SRC		
1NYW91/2	BIT NQ2 10/15 PREM 20CT R SRC	10/15	PREM	20.25CT	R	SRC		
1NYB85/3	BIT NQ2 15/25 SEL 20CT R SRC SW	15/25	SEL	19.75CT	R	SRC	SW	
1NYB85/1	BIT NQ2 15/25 SEL 22CT R SRC	15/25	SEL	21.50CT	R	SRC		
1NYF85/1	BIT NQ2 15/25 SEL 23CT R PC	15/25	SEL	23.00CT	R	PC		
1NYB85/2	BIT NQ2 15/25 SEL 24CT R SRC	15/25	SEL	23.75CT	R	SRC		
1NYB81/3	BIT NQ2 15/25 PREM 25CT R SRC	15/25	PREM	25.00CT	R	SRC		
1NYB75/1	BIT NQ2 25/35 SEL 18CT R SRC	25/35	SEL	18.25CT	R	SRC		
1NY383/1	BIT NQ2 25/35 SPL 23CT R 3STP	25/35	SPL	22.50CT	R	3 STP		
1NY375/4	BIT NQ2 35/45 SEL 22CT R 3STP	35/45	SEL	21.50CT	R	3 STP		
1NY353/2	BIT NQ2 45/55 SPL 18CT R 3STP	45/55	SPL	18.25CT	R	3 STP		
1NY353/1	BIT NQ2 70/90 SPL 13CT R 3STP	70/90	SPL	13.00CT	R	3 STP		
1NY431/1	BIT NQ2 70/90 PREM 15CT R 3STP	70/90	PREM	15.50CT	R	3 STP		

BOART LONGYEAR OFFERS COMPLETE CUSTOM DESIGN SERVICES. SEE PAGE 20 FOR DETAILS.

NQ[®]3

NQ[®]3

ITEM	DESCRIPTION	DIAMOND SIZE	DIAMOND GRADE	TOTAL DIAMOND	GAUGE	CROWN PROFILE	W/W OPTION	OTHER
1NTB95/2	BIT NQ3 6/10 SEL 38CT R SRC	6/10	SEL	38.25CT	R	SRC		
1NTB95/1	BIT NQ3 10/15 SEL 31CT R SRC	10/15	SEL	31.00CT	R	SRC		
4102970	BIT NQ3 15/25 SEL 24CT S 6STP FD	15/25	SEL	23.75CT	S	6 STP	FD	
2NT385/1	BIT NQ3 15/25 SEL 28CT S 3STP	15/25	SEL	28.25CT	S	3STP		
1NTB75/1	BIT NQ3 25/35 SEL 20CT R SRC	25/35	SEL	19.50CT	R	SRC		
2NT375/2	BIT NQ3 25/35 SEL 22CT S 3STP FD	25/35	SEL	21.50CT	S	3 STP	FD	
2NT375/1	BIT NQ3 25/35 SEL 22CT S 3STP	25/35	SEL	22.00CT	S	3 STP		
4101745	BIT NQ3 25/35 SEL 24CT S 7STP	25/35	SEL	24.25CT	S	7 STP		
1NTF75/3	BIT NQ3 25/35 SEL 25CT R PC	25/35	SEL	24.75CT	R	PC		
1NT485/2	BIT NQ3 25/35 SEL 26CT R 4STP	25/35	SEL	26.25CT	R	4 STP		
4060202	BIT NQ3 35/45 SEL 17CT S SRC FD	35/45	SEL	17.00CT	S	SRC	FD	
2NT365/2	BIT NQ3 35/45 SEL 17CT S 3STP FD	35/45	SEL	17.25CT	S	3 STP	FD	
1NT475/1	BIT NQ3 35/45 SEL 21CT R 4STP	35/45	SEL	20.50CT	R	4 STP		
2NT365/1	BIT NQ3 45/55 SEL 15CT S 3STP FD	45/55	SEL	14.50CT	S	3 STP	FD	
2NTF45/1	BIT NQ3 55/70 SEL 14CT S PC	55/70	SEL	13.50CT	S	PC		
1NT343/1	BIT NQ3 55/70 SPL 16CT R 3STP	55/70	SPL	16.25CT	R	3 STP		

ITEM	DESCRIPTION	DIAMOND SIZE	DIAMOND GRADE	TOTAL DIAMOND	GAUGE	CROWN PROFILE	W/W OPTION	OTHER
1HQB95/7	BIT HQ 6/10 SEL 49CT R SRC	6/10	SEL	48.75CT	R	SRC		
AHQF95/6	BIT HQ 6/10 SEL 55CT OS 3.895 PC	6/10	SEL	54.25CT	OS (3.895)	PC		
AHQW93/2	BIT HQ 6/10 SPL 40CT OS 3.895 SRC	6/10	SPL	40.00CT	OS (3.895)	SRC		
1HQW93/2	BIT HQ 6/10 SPL 43CT R SRC	6/10	SPL	43.00CT	R	SRC		
1HQW93/1	BIT HQ 6/10 SPL 43CT R SRC	6/10	SPL	43.00CT	R	SRC		
2HQ395/1	BIT HQ 10/15 SEL 37CT S 3STP	10/15	SEL	36.75CT	S	3 STP		
4015667	BIT HQ 10/15 SEL 49CT S 4 STP	10/15	SEL	48.50CT	S	4 STP		
1HQF95/1	BIT HQ 10/15 SEL 49CT R PC	10/15	SEL	49.00CT	R	PC		
AHQB85/4	BIT HQ 15/25 SEL 27CT OS 3.895 SRC	15/25	SEL	27.00CT	OS (3.895)	SRC		
AHQB85/1	BIT HQ 15/25 SEL 34CT OS 3.895 SRC	15/25	SEL	34.00CT	OS (3.895)	SRC		
1HQF85/6	BIT HQ 15/25 SEL 37CT R PC	15/25	SEL	36.75CT	R	PC		
4015690	BIT HQ 15/25 SEL 40CT S PC	15/25	SEL	39.75CT	S	PC		
2HQ295/1	BIT HQ 15/25 SEL 41CT S 2 STP	15/25	SEL	41.00CT	S	2 STP		
2HQ385/1	BIT HQ 25/35 SEL 28CT S 3STP	25/35	SEL	28.00CT	S	3 STP		
4103760	BIT HQ 25/35 SEL 29CT S 6STP	25/35	SEL	28.50CT	S	6 STP		
2HQB75/2	BIT HQ 25/35 SEL 29CT S SRC	25/35	SEL	29.00CT	S	SRC		
4018840	BIT HQ 25/35 SEL 31CT S 3STP	25/35	SEL	30.50CT	S	3 STP		
1HQF75/1	BIT HQ 25/35 SEL 31CT R PC	25/35	SEL	31.00CT	R	PC		
4018112	BIT HQ 25/35 SEL 32CT S PC	25/35	SEL	31.50CT	S	PC		
1HQ385/2	BIT HQ 25/35 SEL 34CT R 3STP	25/35	SEL	34.00CT	R	3 STP		
1HQ383/1	BIT HQ 25/35 SPL 34CT R 3STP	25/35	SPL	34.00CT	R	3 STP		
1HQ485/3	BIT HQ 25/35 SEL 34CT R 4STP	25/35	SEL	34.00CT	R	4 STP		

BOART LONGYEAR OFFERS COMPLETE CUSTOM DESIGN SERVICES. SEE PAGE 20 FOR DETAILS.

ITEM	DESCRIPTION	DIAMOND SIZE	DIAMOND GRADE	TOTAL DIAMOND	GAUGE	CROWN PROFILE	W/W OPTION	OTHER
4015772	BIT HQ 25/35 PREM 32CT S PC	25/35	PREM	31.50CT	S	PC		
4102341	BIT HQ 25/45 SEL 26CT S 7STP	35/45	SEL	26.26CT	S	7 STP		
4018743	BIT HQ 35/45 SEL 27CT S 3STP	35/45	SEL	26.75CT	S	3 STP		
2hqb65/1	BIT HQ 35/45 SEL 30CT S SRC	35/45	SEL	30.00 CT	S	SRC		
4015666	BIT HQ 35/45 SPL 34CT S 4STP	35/45	SPL	34.25CT	S	4 STP		
4018842	BIT HQ 45/55 SEL 22CT S 3STP	45/55	SEL	21.75CT	S	3 STP		
4042461	BIT HQ 45/55 SEL 22CT S 4STP	45/55	SEL	22.25CT	S	4 STP		
4042463	BIT HQ 55/70 SEL 22CT S 4STP	55/70	SEL	22.00CT	S	4 STP		
4060170	BIT HQ 55/70 SEL 26CT S 7STP	55/70	SEL	25.75CT	S	7 STP		
1HQ465/3	BIT HQ 55/70 SEL 26CT R 4STP	55/70	SEL	26.00CT	R	4 STP		
4103795	BIT HQ 55/70 SPL 24CT S PC	55/70	SPL	23.50CT	S	PC		
CHQT85/1	BIT PLUG HQ 15/25 SEL 65CT OS 3.895 CC	15/25	SEL	65.00CT	OS (3.895)	CC		
CHRT85/1	BIT PLUG HQ R/B 15/25 SEL 65CT OS 3.895 CC	15/25	SEL	65.00CT	OS (3.895)	CC		
3HQT45/1	BIT PLUG HQ 55/70 SEL R	55/70	SEL	27.75CT	R	CC		

HQ®3

HQ®3

ITEM	DESCRIPTION	DIAMOND SIZE	DIAMOND GRADE	TOTAL DIAMOND	GAUGE	CROWN PROFILE	W/W OPTION	OTHER
4049791	BIT HQ3 6/10 SEL 52CT S 4STP	6/10	SEL	52.25CT	S	4STP		
AHTB95/2	BIT HQ3 10/15 SEL 38CT OS 3.895 SRC	10/15	SEL	38.00CT	OS (3.895)	SRC		
1HTF95/1	BIT HQ3 10/15 SEL 52CT R PC	10/15	SEL	52.00CT	R	PC		
2HT381/1	BIT HQ3 10/15 PREM 37CT S 3STP	10/15	PREM	37.00CT	S	3 STP		
4106105	BIT HQ3 15/25 SEL 26CT S 7STP	15/25	SEL	25.50CT	S	7 STP		
4106068	BIT HQ3 15/25 SEL 35CT S 4STP FD	15/25	SEL	34.50CT	S	4 STP	FD	
4106065	BIT HQ3 15/25 SEL 35CT S 7STP FD	15/25	SEL	35.00CT	S	7 STP	FD	
4104415	BIT HQ3 15/25 SEL 49CT S 7STP	15/25	SEL	48.75CT	S	7 STP		
1HTF75/1	BIT HQ3 25/35 SEL 30CT R PC	25/35	SEL	30.00CT	R	PC		
1HTF75/8	BIT HQ3 25/35 SEL 31CT R PC FD	25/35	SEL	31.00CT	R	PC	FD	
1HTF75/4	BIT HQ3 25/35 SEL 34CT R PC	25/35	SEL	34.00CT	R	PC		
4102010	BIT HQ3 25/35 SEL 36CT S 7STP	25/35	SEL	36.00CT	S	7 STP		
1HTF75/6	BIT HQ3 25/35 SEL 36CT R PC	25/35	SEL	36.25CT	R	PC		
1HT483/1	BIT HQ3 25/35 SPL 33CT R 4STP	25/35	SPL	32.50CT	R	4 STP		
1HT383/1	BIT HQ3 25/35 SPL 36CT R 3STP	25/35	SPL	36.00CT	R	3 STP		
4049454	BIT HQ3 35/45 SEL 24CT S SRC FD	35/45	SEL	23.75CT	S	SRC	FD	
4049455	BIT HQ3 35/45 SEL 25CT S FD	35/45	SEL	24.75CT	S	PC	FD	
4049664	BIT HQ3 35/45 SEL 28CT R PC	35/45	SEL	27.75CT	R	PC		
ahtb65/2	BIT HQ3 35/45 SEL 29CT OS 3.895 SRC	35/45	SEL	28.50CT	OS (3.895)	SRC		
4106370	BIT HQ3 45/55 SEL 19CT S 5STP FD DA	45/55	SEL	19.00CT	S	5 STP	FD, DA	

BOART LONGYEAR OFFERS COMPLETE CUSTOM DESIGN SERVICES. SEE PAGE 20 FOR DETAILS.

PQ®

PQ®

ITEM	DESCRIPTION	DIAMOND SIZE	DIAMOND GRADE	TOTAL DIAMOND	GAUGE	CROWN PROFILE	W/W OPTION	OTHER
1PQB95/2	BIT PQ 10/15 SEL 82CT R SRC	10/15	SEL	81.50CT	R	SRC		
1PQB93/1	BIT PQ 10/15 SPL 80CT R SRC	10/15	SPL	80.00CT	R	SRC		
4105755	BIT PQ 25/35 SEL 29CT S 4STP FD	25/35	SEL	29.00CT	S	4 STP	FD	
2PQ485/1	BIT PQ 25/35 SEL 42CT S 4STP	25/35	SEL	42.25CT	S	4STP		
1PQ485/1	BIT PQ 25/35 SEL 44CT R 4STP	25/35	SEL	44.25CT	R	4STP		
4019148	BIT PQ 35/45 SEL 36CT S 4STP	35/45	SEL	35.75CT	S	4STP		
2PQB65/1	BIT PQ 35/45 SEL 42CT S SRC	35/45	SEL	42.00CT	S	SRC		

PQ[®]3

PQ[®]3

ITEM	DESCRIPTION	DIAMOND SIZE	DIAMOND GRADE	TOTAL DIAMOND	GAUGE	CROWN PROFILE	W/W OPTION	OTHER
APTB95/1	BIT PQ3 6/10 SEL 76CT OS 5.125 SRC	6/10	SEL	75.50CT	OS (5.125)	SRC		
1PTF95/3	BIT PQ3 10/15 SEL 61CT R PC FD	10/15	SEL	61.00CT	R	PC	FD	
1PTF95/2	BIT PQ3 10/15 SEL 65CT R PC	10/15	SEL	65.25CT	R	PC		
4106060	BIT PQ3 15/25 SEL 37CT S 7STP FD	15/25	SEL	37.25CT	S	7 STP	FD	
4106056	BIT PQ3 15/25 SEL 40CT S 4STP FD	15/25	SEL	40.00CT	S	4 STP	FD	
2PT485/3	BIT PQ3 15/25 SEL 52CT S 4STP	15/25	SEL	52.00CT	S	4 STP		
2PT485/2	BIT PQ3 15/25 SEL 52CT S 4STP FD	15/25	SEL	52.00CT	S	4 STP	FD	
1PTB85/1	BIT PQ3 15/25 SEL 53CT R SRC	15/25	SEL	53.00CT	R	SRC		
1PTF85/2	BIT PQ3 15/25 SEL 60CT R PC	15/25	SEL	59.75CT	R	PC		
4049622	BIT PQ3 25/35 SEL 45CT S 4STP FD DA	25/35	SEL	44.75CT	S	4 STP	FD, DA	
1PTF75/3	BIT PQ3 25/35 SEL 49CT R PC	25/35	SEL	48.50CT	R	PC		
2PT365/5	BIT PQ3 45/55 SEL 35CT S 3STP FD	45/55	SEL	35.00CT	S	3 STP	FD	

THIS PAGE LEFT INTENTIONALLY BLANK

LONGYEAR® TSD BITS

TSD OVERVIEW **102**

PART NUMBERS **103**

TSD BIT ORDERING DETAILS..... 103
Q® SIZES 105
METRIC SIZES 106



TSD OVERVIEW

THERMALLY STABLE DIAMOND BITS (TSD)

TSD cutters are smaller and generally more robust than PCD cutters. The inserts are set in a tough wear-resistant matrix body and feature broached gauge reinforcements. Cutters are placed to provide full coverage across the cutting face.

These bits are suitable for drilling soft to medium-hard formations depending on the power of the drill rig. The smaller, more robust cutters make this bit usable in rock types that are somewhat harder than those which can be drilled with PCD bits.



TSD BIT ORDERING DETAILS

READING A LONGYEAR® TSD BIT DESCRIPTION:

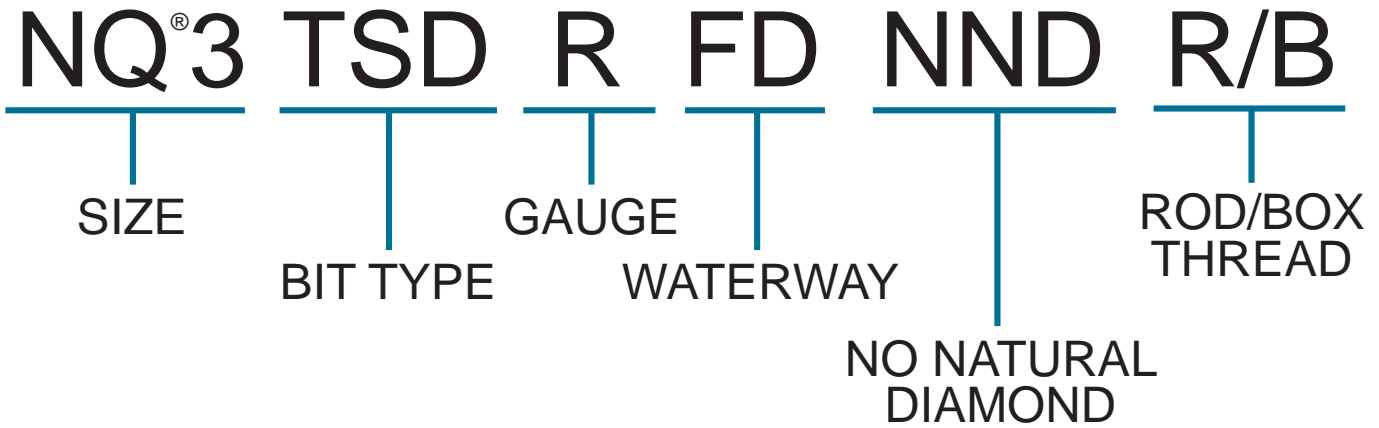

SIZE

Longyear® bits are available in all standard drilling sizes as well as a number a region-specific sizes.

GAUGE

Longyear® TSD bits are available in two standard gauge configurations.

- EQUAL TO REAMING SHELL GAUGE (R)
- OVERSIZED OD (OS, INCHES)

WATERWAY OPTION

Where applicable, waterway options will be identified here.

- DEEP ID (DD)
- FACE DISCHARGE (FD)

NO NATURAL DIAMOND

Only synthetic diamonds are used throughout.

ROD/BOX THREAD

- ROD BOX (R/B)
- ROD PIN (R/P)

THIS PAGE LEFT INTENTIONALLY BLANK

A,B,N,H

A

ITEM	DESCRIPTION	THREAD	GAUGE	W/W OPTION	OTHER
4014492	BIT PLUG AQ R/B TSD R	AQ R/B	R		
CAR0VC/2	BIT PLUG ARQ R/B TSD OS 1.910	ARQ R/B	OS (1.910)		
captvc/5	BIT PLUG AW R/P TSD OS 2.250	AW R/P	OS (2.25)		

B

ITEM	DESCRIPTION	THREAD	GAUGE	W/W OPTION	OTHER
1BYBVC/1	BIT BQTK TSD R	BQTK	R		

N

ITEM	DESCRIPTION	THREAD	GAUGE	W/W OPTION	OTHER
1NQBVC/8	BIT NQ TSD R	NQ	R		
4012131	BIT NQ TSD R NND	NQ	R		NND
4015817	BIT NQ TSD R NND	NQ	R		NND
ANYBVC/5	BIT NQTK TSD OS 3.125	NQTK	OS (3.125)		
1NYBVC/5	BIT NQTK TSD R	NQTK	R		
1NYBVC/4	BIT NQTK TSD R	NQTK	R		
1NTBVC/6	BIT NQ3 TSD R NND	NQ3	R		NND
1NTBVC/7	BIT NQ3 TSD R FD NND	NQ3	R	FD	NND

H

ITEM	DESCRIPTION	THREAD	GAUGE	W/W OPTION	OTHER
1HQBVC/8	BIT HQ TSD R	HQ	R		
4013144	BIT HQ TSD R	HQ	R		
4015989	BIT HQ TSD R	HQ	R		
4018697	BIT HQ TSD R FD NND	HQ	R	FD	NND
AHTBVC/9	BIT HQ3 TSD OS 3.895 ID	HQ3	OS (3.895)	DD	TSD ROUNDS
1HTBVC/4	BIT HQ3 TSD R	HQ3	R		
1HTBVC/5	BIT HQ3 TSD R NND	HQ3	R		NND
1HTBVC/6	BIT HQ3 TSD R FD	HQ3	R	FD	

P, METRIC

P

ITEM	DESCRIPTION	THREAD	GAUGE	W/W OPTION	OTHER
4049428	BIT PQ TSD R NND	PQ	R		NND
4060230	BIT PQ TSD R FD	PQ	R	FD	
1PTBVC/3	BIT PQ3 TSD R	PQ3	R		
1PTBVC/4	BIT PQ3 TSD R	PQ3	R		
1PTBVC/2	BIT PQ3 TSD R FD	PQ3	R	FD	
APTBVC/3	BIT PQ3 TSD OS 5.850	PQ3	OS (5.850)		TSD Rounds

T-6

ITEM	DESCRIPTION	THREAD	GAUGE	W/W OPTION	OTHER
4049673	BIT T6-131 TSD R FD	T6-131	R	FD	

LONGYEAR® PCD BITS

PCD OVERVIEW **108**

PART NUMBERS **109**

PCD BIT ORDERING DETAILS..... 109

Q® SIZES 111

API SIZES 113



PCD OVERVIEW

POLYCRYSTALLINE COMPACT DIAMOND BITS

Ideal for drilling in soft to medium sedimentary formations which are homogeneous and competent. The PCD cutters are available in several sizes and are located to yield maximum penetration rate and long life depending on the application. The bits are constructed with a tough, wear-resistant matrix body and gauge reinforcement. As a result, worn cutters can be rotated or replaced allowing the continued use of the bit.



PCD ORDERING DETAILS

READING A LONGYEAR® PCD BIT DESCRIPTION:

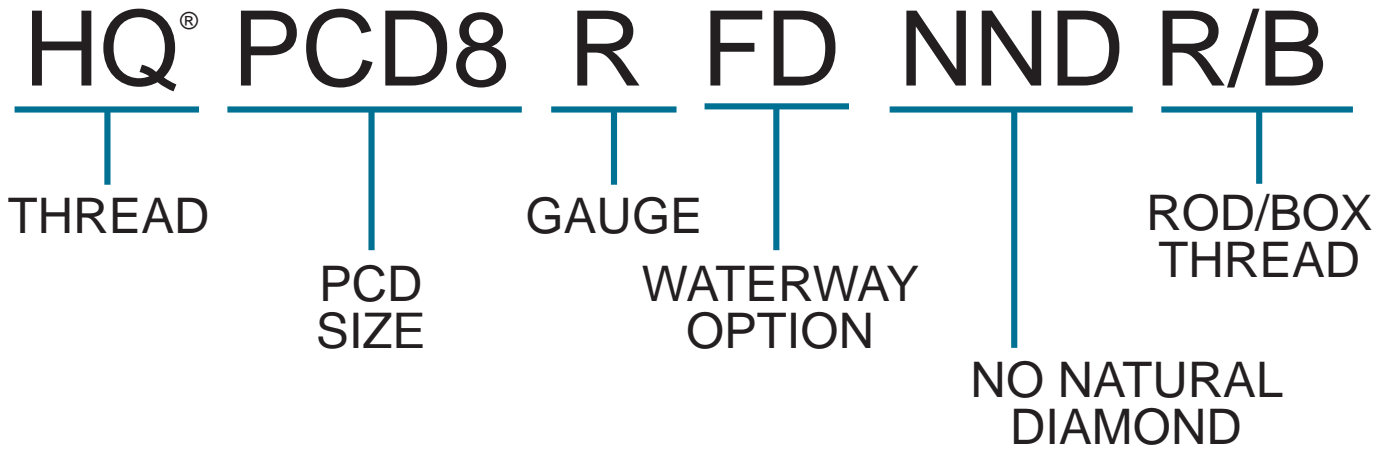

THREAD

Longyear® bits are available in all standard drilling thread types as well as a number a region-specific sizes.

PCD SIZE

Standard Longyear® PCD bits are available with either 8mm or 13mm PCD cutters.

GAUGE

Longyear® PCD bits are available in three standard gauge configurations.

- STANDARD GAUGE (S)
- EQUAL TO REAMING SHELL GAUGE (R)
- OVERSIZED OD (OS, INCHES)

WATERWAY OPTION

Where applicable, waterway options will be identified here.

- DOUBLE ANGLE (DA)
- FACE DISCHARGE (FD)

NO NATURAL DIAMOND

Only synthetic diamonds are used throughout.

ROD/BOX THREAD

- ROD BOX (R/B)
- ROD PIN (R/P)

THIS PAGE LEFT INTENTIONALLY BLANK

A

ITEM	DESCRIPTION	THREAD	CORE OR PLUG	PCD SIZE	GAUGE	W/W OPTION	OTHER
CAP0VA/6	BIT PLUG AW R/P PCD8 OS 2.500	AW R/P	Plug	8mm	OS (2.5)		
CAPOVA/3	BIT PLUG AW R/P PCD8 OS 2.250	AW R/P	Plug	8mm	OS (2.25)		
4103555	BIT PLUG AW R/P PCD8 OS 2.00	AW R/P	Plug	8mm	OS (2.00)		

N

ITEM	DESCRIPTION	THREAD	CORE OR PLUG	PCD SIZE	GAUGE	W/W OPTION	OTHER
1NQEVA/4	BIT NQ PCD13 R NND	NQ	Core	13mm	R		NND
3NR0VA/2	BIT PLUG NQ R/B PCD13 R	NQ R/B	Plug	13mm	R		
1NYEVA/1	BIT NQ2 PCD8 R	NQ2	Core	8mm	R		
4104648	BIT PLUG NW R/P PCD13 OS 96MM	NW R/P	Plug	13	OS (96mm)		
4060393	BIT PLUG NW R/P PCD13 OS 99MM	NW R/P	Plug	13	OS (99mm)		
4060393	BIT PLUG NW R/P PCD13 OS 3.898	NW R/P	Plug	13mm	OS (3.898)		
CNPEVA/1	BIT PLUG NW R/P PCD13 OS 3.782	NW R/P	Plug	13mm	OS (3.782)		
CNPEVA/5	BIT PLUG NW R/P PCD8 OS 3.782	NW R/P	Plug	8mm	OS (3.782)		
3NP0VA/3	BIT PLUG NW R/P PCD13 OS 2.938	NW R/P	Plug	13mm	OS (2.938)		
CNPEVA/7	BIT PLUG NW R/P PCD13 OS 3.782	NW R/P	Plug	13mm	OS(3.782)		Relief Port for DHM
4106260	BIT PLUG NW R/P PCD13 OS 125MM	NW R/P	PLUG	13	OS (125MM)		
CNPEVA/6	BIT PLUG NW R/P PCD8 OS 3.782	NW R/P	Plug	8mm	OS(3.782)		Relief Port for DHM
4105780	BIT PLUG NW R/P PCD13 OS 4.827	NW R/P	Plug	13mm	OS(4.827)		

H

ITEM	DESCRIPTION	THREAD	CORE OR PLUG	PCD SIZE	GAUGE	W/W OPTION	OTHER
1HQEVA/6	BIT HQ PCD13 R NND	HQ	Core	13mm	R		NND
1HQEVA/7	BIT HQ PCD8 R NND	HQ	Core	8mm	R		NND
3HR0VA/1	BIT PLUG HQ R/B PCD13 R	HQ	Plug	13mm	R		
4018758	BIT HQ PCD13 R	HQ	Core	13mm	R		
AHQE-VA/10	BIT HQ PCD13 OS 4.25 FD	HQ	Core	13mm	OS (4.250)	FD	
CHR0VA/2	BIT PLUG HQ R/B PCD13 OS 3.937	HQ R/B	PLUG	13	OS (3.937)		
CHRTVA/1	BIT HQ R/B PLUG PCD13 OS 3.937	HQ R/B	PLUG	13	OS (3.937)		
4105835	BIT HQ3 PCD8 R FD	HQ3	Core	8mm	R	FD	
AHTEVA/5	BIT HQ3 PCD13 OS 3.895	HQ3	Core	13mm	OS (3.895)	FD	
1H8EVA/2	BIT HQT T PCD13 R FD	HQT T	Core	13mm	R	FD	

BOART LONGYEAR OFFERS COMPLETE CUSTOM DESIGN SERVICES. SEE PAGE 20 FOR DETAILS.

P

P

ITEM	DESCRIPTION	THREAD	CORE OR PLUG	PCD SIZE	GAUGE	W/W OPTION	OTHER
APQEVA/2	BIT PQ PCD13 OS 5.00	PQ	Core	13mm	OS (5.00)		
4018816	BIT PQ3 PCD13 R FD DA	PQ3	Core	13mm	R	FD, DA	
1PTEVA/1	BIT PQ3 PCD13 R	PQ3	Core	13mm	R		
4103260	BIT PQTT PCD8 S FD	PQTT	Core	8mm	S	FD	
4018928	BIT PWF-CL PCD 13 CORE OS 4.748 FD	PWF-CL	Core	13mm	OS (4.748)	FD	
4060390	BIT 4" LY PCD 13 CORE OS 6.125	4" LY	Core	13mm	OS (6.125)	FD	

API

API

ITEM	DESCRIPTION	THREAD	CORE OR PLUG	PCD SIZE	GAUGE	W/W OPTION	OTHER
3000VA/11	BIT PLUG 3 7/8 PCD13 OS 3.875	3 7/8	Plug	13mm	OS (3.875)		
4015570	BIT 5.5 PCD13 OS 5.50 DD	5.5	Core	13mm	OS (5.50)	DD	
300TVA/15	BIT PLUG 5.625 PCD13 OS 5.625	5.625	Plug	13mm	OS (5.625)		
4018000	BIT 5.75 PCD13 OS 5.75 DD	5.75	Core	13mm	OS (5.75)	DD	
4011443	BIT 6.125 PCD13 OS 6.125 DD	6.125	Core	13mm	OS (6.125)	DD	
4049792	BIT 6.25 PCD13 OS 6.250 DD	6.25	Core	13mm	OS (6.250)	DD	
4105060	BIT 5.5x4 PCD8 OS 5.469 FD	5.5	Core	8mm	OS (5.469)	FD	

THIS PAGE LEFT INTENTIONALLY BLANK

LONGYEAR® CARBIDE BITS

CARBIDE OVERVIEW 116

PART NUMBERS 117

CARBIDE BIT ORDERING DETAILS.....117
ALL SIZES119

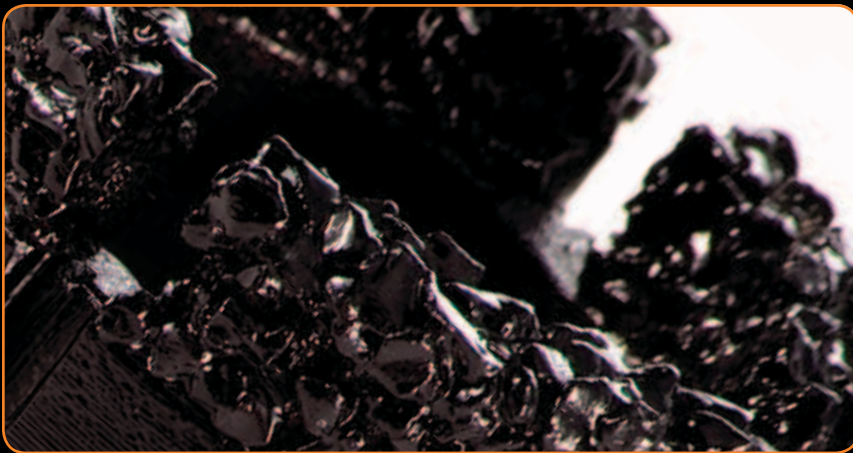

CARBIDE OVERVIEW

Longyear® carbide products are designed for drilling in soft-to-medium rock formations and overburden conditions.

CARBIDE CHIP DEVIL'S NIGHTMARE

The Devil's Nightmare is aggressive – the special carbide that is used maximizes its capabilities. With efficient flushing characteristics, it offers high performance in a variety of applications ranging from soils to soft rock formations.



CARBIDE BIT ORDERING DETAILS

READING A LONGYEAR® CARBIDE BIT DESCRIPTION:

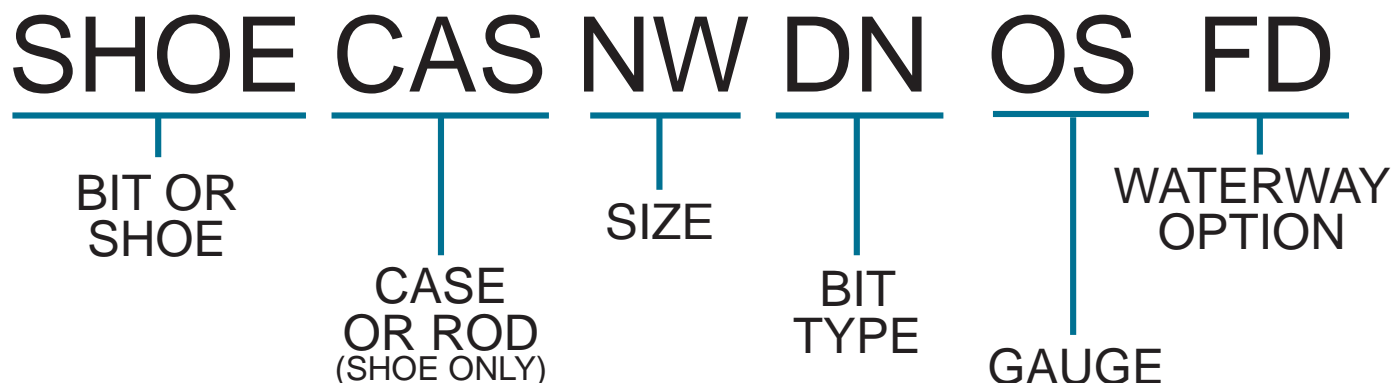

CASE OR ROD

Longyear® casing shoes are available in both casing (CAS) and rod (ROD) shoe configurations.

SIZE

Longyear® bits are available in all standard drilling sizes as well as a number a region-specific sizes.

BIT TYPE

DEVIL'S NIGHTMARE (DN)

GAUGE

Longyear® carbide bits are available in three standard OD gauge configurations.

- STANDARD GAUGE (S)
- EQUAL TO REAMING SHELL GAUGE (R)
- OVERSIZED OD (OS, INCHES)

WATERWAY OPTION

Where applicable, waterway options will be identified here.

- DOUBLE ANGLE (DA)
- FACE DISCHARGE (FD)

THIS PAGE LEFT INTENTIONALLY BLANK

DEVIL'S NIGHTMARE

ALL SIZES

ITEM	DESCRIPTION	SIZE	PROFILE	GAUGE	W/W OPTION	OTHER
DAWEVP/1	SHOE CAS AW DN OS 2.485	AW		OS 2.485		CASING SHOE
4102969	BIT BW44 DN R	BW44		R		
4NWEVP/2	SHOE CAS NW DN R	NW		R		CASING SHOE
DNWEVP/1	SHOE CAS NW DN OS 3.875	NW		OS 3.875		CASING SHOE
DNWEVP/6	SHOE CAS NW DN OS 3.875	NW		OS 3.875		HD CASING SHOE
4019419	BIT NWD4 DN R DD	NWD4		R	DD	
1NQEVP/1	BIT NQ DN R	NQ		R		
ANYEVP/1	BIT NQ2 DN OS 3.032	NQ2		OS 3.032		
1NYEVP/1	BIT NQ2 DN R	NQ2		R		
1NTEVP/1	BIT NQ3 DN R	NQ3		R		
4HWEVP/1	SHOE CAS HW DN R	HW		R		CASING SHOE
DHWEVP/4	SHOE CAS HW DN OS 4.765	HW		OS 4.765		CASING SHOE
DHWEVP/1	SHOE CAS HW DN OS 4.875	HW		OS 4.875		CASING SHOE
1HGEVP/2	BIT HWD4 DN R FD	HWD4		R	FD	
AHGEVP/1	BIT HWD4 DN OS 3.750	HWD4		OS 3.75		
4HJEVP/1	SHOE CAS HWT DN R	HWT		R		CASING SHOE
DHJEVP/1	SHOE CAS HWT DN OS 4.875	HWT		OS 4.875		CASING SHOE
4HREVP/2	SHOE ROD HQ DN S	HQ		S		ROD SHOE
1HQEVP/1	BIT HQ DN R	HQ		R		
AHQEVP/2	BIT HQ DN OS 3.830	HQ		OS 3.830		
DHREVP/1	SHOE ROD HQ DN OS 3.875	HQ		OS 3.875		ROD SHOE
4102455	BIT HQ3 DN S FD DA	HQ3		S	FD DA	

BOART LONGYEAR OFFERS COMPLETE CUSTOM DESIGN SERVICES. SEE PAGE 20 FOR DETAILS.

DEVIL'S NIGHTMARE

ALL SIZES

ITEM	DESCRIPTION	SIZE	PROFILE	GAUGE	W/W OP-TION	OTHER
1HTEVP/1	BIT HQ3 DN R	HQ3		R		
1HTEVP/2	BIT HQ3 DN R FD	HQ3		R	FD	
DPWEVP/1	BIT PW DN OS 5.790	PW		OS 5.790		
DPWEVP/6	BIT PW DN OS 6.500	PW		OS 6.500		
4PWEVP/1	BIT PW DN R	PW		R		
DPJEVP/1	BIT PWT DN OS 5.790	PWT		OS 5.790		
1PQEV/1	BIT PQ DN R	PQ		R		
1PREVP/1	BIT PQ R/P DN R	PQ R/P		R		
4PREVP/1	SHOE ROD PQ DN R	PQ		R		ROD SHOE
1PTEVP/2	BIT PQ3 DN R FD	PQ3		R	FD	
4019242	BIT T6-116 DN S	T6-116		S		
4UWEVP/3	SHOE CAS UW DN R	UW		R		CASING SHOE

LONGYEAR® REAMING SHELLS

REAMING SHELL OVERVIEW 122

PART NUMBERS 124

REAMING SHELL ORDERING DETAILS..... 124

Q® SIZES 125

METRIC SIZES 127



REAMING SHELL OVERVIEW

LONGYEAR® REAMERS UTILIZE A SPIRAL PAD DESIGN WHICH HAS TWO KEY BENEFITS:

Longyear® reamers feature increased stability and reduced vibrations due to the specially designed spiral pads. The design provides increased contact with the circumference of the hole. Longyear® reaming shells experience longer life in the field due to the greater number of diamonds and carbide reinforcements.



1

IMPREGNATED DIAMOND REAMERS (1)
A mixture of large natural stones combined with synthetic stones concentrated on the surface of the reamer pad



2

BROACHED REAMERS (2)
Natural diamonds are placed in a broach that is made up of several half round strips. This is designed to reduce the contact of the reamer on the rock decreasing drag and increasing water flow. Ideal for softer formations

Boart Longyear provides four different types of reamer configurations to ensure the right reamer for the right application. The magnum and premium reamers contain tungsten carbide to absorb impact and improve life through decreasing erosion of the pad.



MAGNUM REAMERS (3)

Have alternating rows of tungsten carbide and TSD pins. Can be used for gathering core samples that can not be contaminated by natural diamond fragments



PREMIUM REAMERS (4)

Contains the most natural diamond content of all the reamers. Each pad is protected with Tungsten carbide strips on both the leading and trailing edges to help protect gauge and improve life

BOART LONGYEAR ALSO PROVIDES THE FOLLOWING SPECIALTY REAMER CONFIGURATIONS:

ROD REAMERS

Used anywhere in the rod string to stabilize the rod. Can also be used to keep the hole to size.

DIAMOND ADAPTER COUPLING

Used to stabilize the core barrel. It contains a rod thread on one side and the core barrel thread on the other. Can also be used to keep the hole to size.

REAMING SHELL ORDERING DETAILS

READING A LONGYEAR® REAMING SHELL DESCRIPTION:

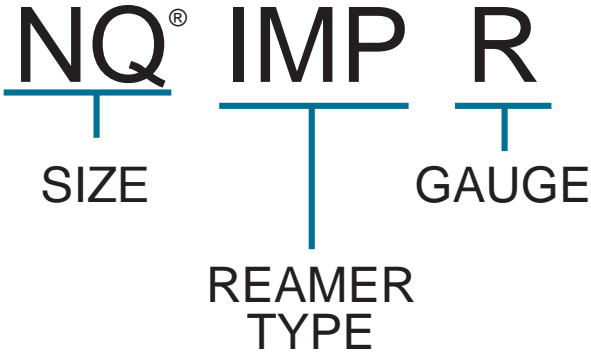

SIZE

Longyear® reaming shells are available in all standard drilling sizes as well as a number a region-specific sizes.

REAMER TYPE

Longyear® reaming shells are available in four standard types. **See page 122 for complete descriptions.**

- DIAMOND IMPREGNATED (IMP)
- MAGNUM (MGM)
- PREMIUM (PREM)
- BROACHED (BROACH)

GAUGE

Longyear® reaming shells are available in three standard gauge configurations.

- STANDARD GAUGE (S)
- EQUAL TO REAMING SHELL GAUGE (R)
- OVERSIZED OD (OS, INCHES)

A, B, N

A

ITEM	DESCRIPTION	SIZE	TYPE	GAUGING	OTHER
4104600	SHELL AQ BROACH R	AQ	BROACH	R	
4060365	SHELL AQTK BROACH R	AQTK	BROACH	R	
4060366	SHELL AQTK IMP R	AQTK	IMPREGNATED	R	
4060367	SHELL AQTK MGM R	AQTK	MAGNUM	R	
4060368	SHELL AQTK PREM R	AQTK	PREMIUM	R	

B

ITEM	DESCRIPTION	SIZE	TYPE	GAUGING	OTHER
4101852	SHELL BQ BROACH R	BQ	BROACH	R	
4101172	SHELL BQ IMP R	BQ	IMPREGNATED	R	
4049500	SHELL BQ MGM R	BQ	MAGNUM	R	
4049825	SHELL BQ PREM R	BQ	PREMIUM	R	
4101853	SHELL AC BQ BROACH R	BQ	BROACH	R	ADAPTOR COUPLING
4101173	SHELL AC BQ IMP R	BQ	IMPREGNATED	R	ADAPTOR COUPLING
4060364	SHELL BQTK BROACH R	BQTK	BROACH	R	
4100968	SHELL BQTK IMP R	BQTK	IMPREGNATED	R	
4060369	SHELL BQTK MGM R	BQTK	MAGNUM	R	
4060370	SHELL BQTK PREM R	BQTK	PREMIUM	R	

N

ITEM	DESCRIPTION	SIZE	TYPE	GAUGING	OTHER
4060371	SHELL NQ BROACH OS 3.032	NQ	BROACH	OS 3.032	
4101847	SHELL NQ BROACH R	NQ	BROACH	R	
4104545	SHELL NQ IMP OS 3.015	NQ	IMPREGNATED	OS 3.015	
4103855	SHELL NQ IMP OS 3.032	NQ	IMPREGNATED	OS 3.032	
4101029	SHELL NQ IMP R	NQ	IMPREGNATED	R	
4018514	SHELL NQ MGM R	NQ	MAGNUM	R	
4060372	SHELL NQ PREM OS 3.032	NQ	PREMIUM	OS 3.032	
4049753	SHELL NQ PREM R	NQ	PREMIUM	R	
4106191	SHELL AC NQ BROACH OS 3.032	NQ	BROACH	OS 3.032	ADAPTOR COUPLING
4101851	SHELL AC NQ BROACH R	NQ	BROACH	R	ADAPTOR COUPLING
4101425	SHELL AC NQ IMP OS 3.020	NQ	IMPREGNATED	OS 3.020	ADAPTOR COUPLING
4104034	SHELL AC NQ IMP OS 3.031	NQ	IMPREGNATED	OS 3.031	ADAPTOR COUPLING
4101174	SHELL AC NQ IMP R	NQ	IMPREGNATED	R	ADAPTOR COUPLING
4049703	SHELL ROD NRQ MGM R	NRQ	MAGNUM	R	ROD
4049626	SHELL ROD NRQ MGM OS 3.307	NRQ	MAGNUM	OS 3.307	ROD

BOART LONGYEAR OFFERS COMPLETE CUSTOM DESIGN SERVICES. SEE PAGE 20 FOR DETAILS.

H, P

H

ITEM	DESCRIPTION	SIZE	TYPE	GAUGING	OTHER
4060375	SHELL HQ BROACH OS 3.830	HQ	BROACH	OS 3.830	
4060376	SHELL HQ BROACH OS 3.895	HQ	BROACH	OS 3.895	
4101854	SHELL HQ BROACH R	HQ	BROACH	R	
4060377	SHELL HQ IMP OS 3.830	HQ	IMPREGNATED	OS 3.830	
4060378	SHELL HQ IMP OS 3.895	HQ	IMPREGNATED	OS 3.895	
4101028	SHELL HQ IMP R	HQ	IMPREGNATED	R	
4018565	SHELL HQ MGM R	HQ	MAGNUM	R	
4060379	SHELL HQ PREM OS 3.830	HQ	PREMIUM	OS 3.830	
4060407	SHELL HQ PREM OS 3.895	HQ	PREMIUM	OS 3.895	
4049766	SHELL HQ PREM R	HQ	PREMIUM	R	
4105458	SHELL AC HQ BROACH OS 3.782	HQ	BROACH	OS 3.782	ADAPTOR COUPLING
4101844	SHELL AC HQ BROACH OS 3.782	HQ	BROACH	OS 3.782	ADAPTOR COUPLING
4104306	SHELL AC HQ BROACH R	HQ	BROACH	R	ADAPTOR COUPLING
4103710	SHELL AC HQ BROACH 3.692	HQ	BROACH	OS 3.692	ADAPTOR COUPLING
4101405	SHELL AC HQ IMP OS 3.823	HQ	IMPREGNATED	OS 3.823	ADAPTOR COUPLING
4101175	SHELL AC HQ IMP R	HQ	IMPREGNATED	R	ADAPTOR COUPLING
6HJR87/1	SHELL ROD HWT MGM R	HWT	MAGNUM	R	ROD
7HJR87/2	SHELL ROD HWT MGM R	HWT	MAGNUM	R	ROD
4049705	SHELL ROD HRQ MGM R	HRQ	MAGNUM	R	ROD

P

ITEM	DESCRIPTION	SIZE	TYPE	GAUGING	OTHER
4060380	SHELL PQ BROACH OS 4.950	PQ	BROACH	OS 4.950	
4102395	SHELL PQ BROACH R	PQ	BROACH	R	
4105030	SHELL PQ IMP OS 4.950	PQ	IMPREGNATED	OS 4.950	
4102770	SHELL PQ IMP R	PQ	IMPREGNATED	R	
4018559	SHELL PQ MGM R	PQ	MAGNUM	R	
4060381	SHELL PQ PREM OS 4.950	PQ	PREMIUM	OS 4.950	
4060147	SHELL PQ PREM R	PQ	PREMIUM	R	

METRIC

LTK 48

ITEM	DESCRIPTION	SIZE	TYPE	GAUGING	OTHER
4103057	SHELL LTK48 BROACH OS 1.9	LTK48	BROACH	OS 1.9	
4101849	SHELL LTK48 BROACH R	LTK48	BROACH	R	
4101435	SHELL LTK48 IMP R	LTK48	IMPREGNATED	R	

LTK 60

ITEM	DESCRIPTION	SIZE	TYPE	GAUGING	OTHER
4100948	SHELL LTK 60 BROACH R	LTK60	BROACH	R	
4101341	SHELL LTK60 IMP R	LTK60	IMPREGNATED	R	

CUD

ITEM	DESCRIPTION	SIZE	TYPE	GAUGING	OTHER
4060067	SHELL CUD76 BROACH OS 2.980	CUD 76	BROACH	OS 2.980	
4060091	SHELL CUD96 PREM OS 3.782	CUD 96	PREMIUM	OS 3.782	

THIS PAGE LEFT INTENTIONALLY BLANK

LONGYEAR® WEDGING BITS

WEDGING BIT OVERVIEW **130**

PART NUMBERS **131**

WEDGING BIT ORDERING DETAILS..... 131

Q® SIZES 132



OVERVIEW

DIAMOND WEDGING TOOLS

Boart Longyear® wedging tools are diamond products that are made to follow wedges set in the bore hole with the intention of altering the hole direction. They consist of surface set wedge reamer, surface set bullnose bits, and impregnated tapered crown core bits. These special profiles are required to avoid drilling straight through the wedge.

IMPREGNATED TAPERED CROWN CORE BITS

The combination of diamond and matrix determine the performance of an impregnated bit. The simultaneous erosion of the matrix and the diamonds makes the bit self sharpening. Boart Longyear uses a special matrix which provides optimal performance.

The tapered crown profile is available in a taper varying from 1/4" to 7/16".

WEDGING BIT ORDERING DETAILS

READING A LONGYEAR® WEDGING BIT DESCRIPTION:

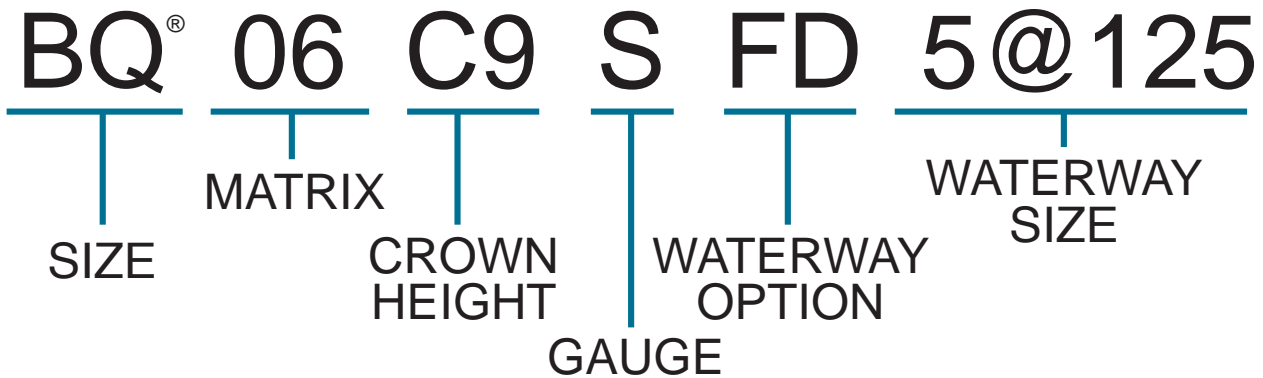

SIZE

Longyear® bits are available in all standard drilling thread types as well as a number a region-specific sizes.

MATRIX

The Longyear® impregnated diamond bit line has been designed to manage an extremely wide variety of ground conditions. **See page 26 for complete details.**

GAUGE

Boart Longyear® bits are available in standard gauge configurations.
STANDARD GAUGE (S)

IMPREG DEPTH

Longyear® wedging bits are currently available in 2 standard impreg depths of 9mm and 12mm.

WATERWAY OPTION

Where applicable, waterway options such as FACE DISCHARGE (FD) will be identified here.

WATERWAY SIZE

Boart Longyear® wedging bits offer the widest variety of waterway sizes in the industry. The description represents the number of waterways and the waterway size:

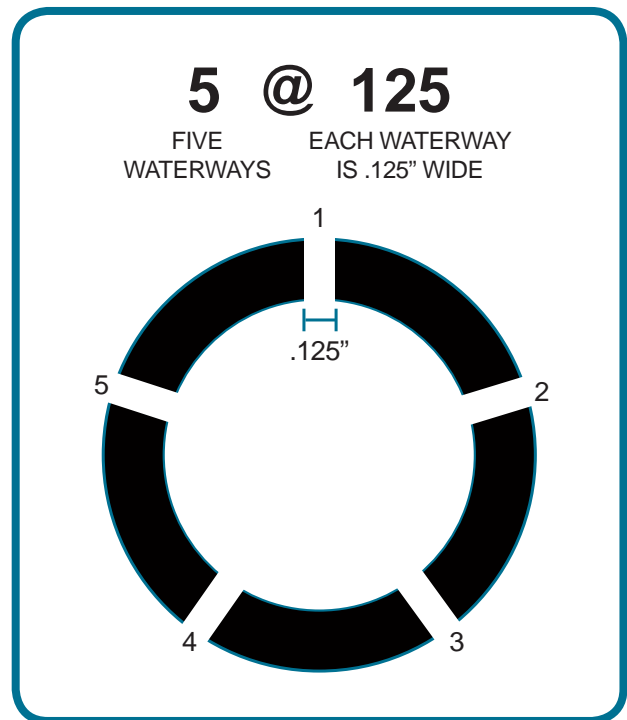

B-H

B-H

ITEM	DESCRIPTION	SERIES	GAUGE	CROWN HEIGHT	W/W OPTION	W/W SIZES	OTHER
4053574	BIT WD BQ 06 C9 S 8@125	6	S	9mm		8@125	3/16 Wedge
4051737	BIT WD BQ 08COM C9 S 8@125	08COM	S	9mm		8@125	3/16 Wedge
4053878	BIT WD BQTK 07 C9 S 8@125	7	S	9mm		8@125	3/16 Wedge
4104109	BIT WD NQ 06 C9 S 8@187	6	S	9mm		8@187	1/4 Wedge
4052304	BIT WD NQ 06 C9 S 10@125	6	S	9mm		10@125	3/16 Wedge
4054235	BIT WD NQ 07 C12 S 6@187	7	S	12mm		6@187	3/8 Wedge
4052772	BIT WD NQ 07 C9 S 10@125	7	S	9mm		10@125	3/16 Wedge
4054175	BIT WD NQ 08 C9 R 8@155	8	R	9mm		8@155	3/16 Wedge
4052005	BIT WD NQ 08 C9 S 10@125	8	S	9mm		10@125	3/16 Wedge
4106167	BIT WD NQ 09COM C12 S 6@187	09COM	S	12mm		6@187	3/8 Wedge
4053000	BIT WD NQ 10COM C9 S 10@125	10COM	S	9mm		10@125	3/16 Wedge
4052454	BIT WD NQ2 08 C9 S 10@125	8	S	9mm		10@125	3/16 Wedge
4106168	BIT WD NQ2 09 C9 S 6@187	9	S	12mm		6@187	5/16 Wedge
4102466	BIT WD HQ 02 C12 S FD 8@250	2	S	12mm	FD	8@250	5/16 Wedge
4052520	BIT WD HQ 06ABR C9 S 9@187	06ABR	S	9mm		9@187	3/16 Wedge
4105891	BIT WD HQ 06 C12 S FD 8@250	6	S	12mm	FD	8@250	5/16 Wedge
4051994	BIT WD HQ 06 C19 S 9@155	6	S	19mm		9@155	7/16 Wedge
4052916	BIT WD HQ 07 C9 S 9@155	7	S	9mm		9@155	3/16 Wedge
4053651	BIT WD HQ 08 C9 S 9@155	8	S	9mm		9@155	3/16 Wedge
4053968	BIT WD HQ 08 C19 S 9@155	8	S	19mm		9@155	7/16 Wedge
4106169	BIT WD HQ 09COM C12 S 8@187	09COM	S	12mm		8@187	7/16 Wedge

LONGYEAR® DIRECTION DRILLING BITS

DIRECTIONAL BIT OVERVIEW 134

PART NUMBERS 135

WEDGING BIT ORDERING DETAILS.....	135
Q® SIZES	136
METRIC SIZES	137
IMPERIAL SIZES	137



OVERVIEW

DIRECTIONAL DRILLING TOOLS

Directional drilling bits are threaded onto downhole motors and used in directional drilling applications. They have reinforced center ports and have an impregnated full face crown.

Boart Longyear® directional drilling bits can also be used as an impregnated plug bit.

IMPREGNATED DIRECTIONAL DRILLING BITS

The combination of diamond and matrix determine the performance of an impregnated bit. The simultaneous erosion of the matrix and the diamonds makes the bit self sharpening. Boart Longyear uses a special matrix which provides optimal performance.

Boart Longyear® directional drilling bits feature threaded ports in shank allow plugs to be threaded to more closely regulate fluid flow.



DIRECTIONAL DRILLING ORDERING DETAILS

READING A LONGYEAR® DIRECTIONAL DRILLING BIT DESCRIPTION:

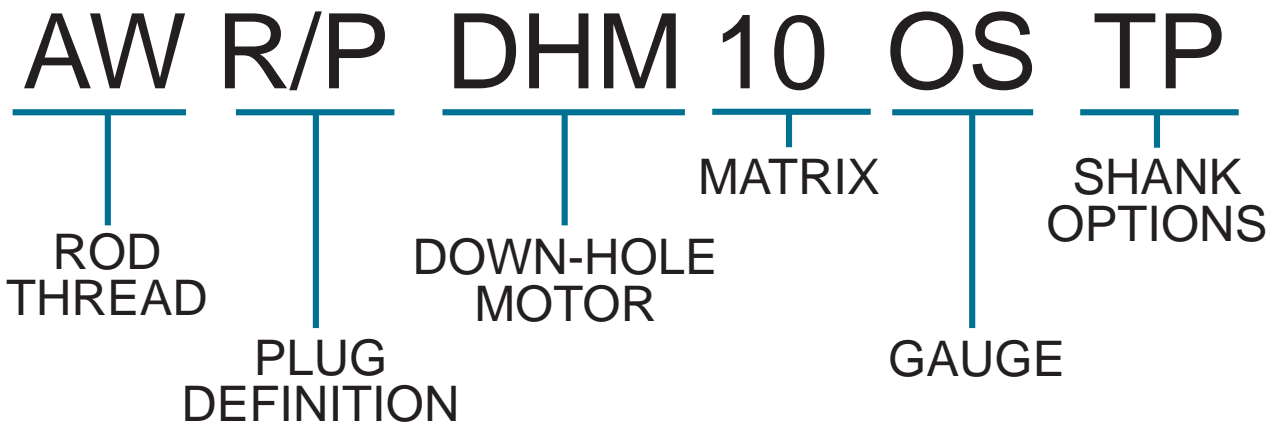

THREAD

Longyear® directional bits are available in a variety standard drilling thread types as well as a number a region-specific sizes.

PLUG DEFINITION

ROD BOX (R/B)
ROD PIN (R/P)

MATRIX

Longyear® impregnated diamond bits are been designed to manage an extremely wide variety of ground conditions. **See page 26 for complete details.**

GAUGE

Longyear® bits are available in three standard gauge configurations.

STANDARD GAUGE (S)
EQUAL TO REAMING SHELL GAUGE (R)
OVERSIZED OD (OS, INCHES)

SHANK OPTIONS

Where applicable, shank options such as THREADED SHANK PORTS (TP) will be identified here.

A-H**A-H**

ITEM	DESCRIPTION	THREAD	SERIES	GAUGE	OTHER
3AJZUF/1	BIT DHM AWJ R/P 04 R	AWJ R/P	4	R	
3AJZUY/1	BIT DHM AWJ R/P 06 R	AWJ R/P	6	R	
3AJZUH/1	BIT DHM AWJ R/B 07 R	AWJ R/B	7	R	
4019134	BIT DHM AW R/P 08ABR OS 2.360	AW R/P	08ABR	OS (2.360)	
4019133	BIT DHM AW R/P 09COM OS 2.360	AW R/P	09COM	OS (2.360)	
4019366	BIT DHM AW R/P 10COM OS 2.360 TP	AW R/P	10COM	OS (2.360)	Threaded shank ports
4049445	BIT DHM AW R/P 10COM OS 2.360	AW R/P	10COM	OS (2.360)	
4104524	BIT DHM AW R/P BL21 OS 2.345 TP	AW R/P	BL21	OS (2.345)	Threaded shank ports
4060285	BIT DHM BW R/P 09COM OS 2.980	BW R/P	09COM	OS (2.980)	
4049470	BIT DHM BQTK 06 R	BQTK	6	R	
3NPZAR/5	BIT DHM NW R/P 08 OS 3.782	NW R/P	9	OS (3.782)	
3NPZAQ/4	BIT DHM NW R/P 10 OS 3.782	NW R/P	10	OS (3.782)	
4104050	BIT DHM NW R/P BL16 OS 3.763 TP	NW R/P	BL16	OS (3.763)	Threaded shank ports
4106496	BIT DHM NW R/P BL19 OS 3.763 TP	NW R/P	BL19	OS (3.763)	Threaded shank ports
4104578	BIT DHM NW R/P BL21 OS 3.763 TP	NW R/P	BL21	OS (3.763)	Threaded shank ports
4049698	BIT DHM NRQ R/B 06ABR R	NRQ R/B	06ABR	R	
4049700	BIT DHM NRQ R/B 08ABR R	NRQ R/B	08ABR	R	
4103235	BIT DHM NRQ R/B BL16 S TP	NRQ R/B	BL16	S	Threaded shank ports
4104650	BIT DHM NRQ R/B BL19 S TP	NRQ R/B	BL19	S	Threaded shank ports
4104525	BIT DHM NRQ R/B BL21 S TP	NRQ R/B	BL21	S	Threaded shank ports
4049701	BIT DHM HRQ R/B 06ABR R	HRQ R/B	06ABR	R	
4049702	BIT DHM HRQ R/B 08ABR R	HRQ R/B	08ABR	R	

METRIC & IMPERIAL

METRIC

ITEM	DESCRIPTION	THREAD	SERIES	GAUGE	OTHER
4049484	BIT DHM LTK60 02 R	LTK60	2	R	
4049512	BIT DHM LTK60 07 R	LTK60	7	R	
4042465	BIT DHM B46 07 S	B46	7	S	

IMPERIAL

ITEM	DESCRIPTION	THREAD	SERIES	GAUGE	OTHER
C00ZUD/1	BIT DHM 2 3/8 API REG R/P 02 OS 3.895	2 3/8 API REG R/P	2	OS 3.895	
C00ZUY/2	BIT DHM 2 3/8 API REG R/P 06ABR OS 3.895	2 3/8 API REG R/P	06ABR	OS 3.895	
C00ZUY/1	BIT DHM 2 3/8 API REG R/P 06 OS 3.895	2 3/8 API REG R/P	6	OS 3.895	
C00ZAR/1	BIT DHM 2 3/8 API REG R/P 08 OS 3.895	2 3/8 API REG R/P	8	OS 3.895	
300ZAR/7	BIT DHM 2 3/8 API REG R/P 08 OS 3.782	3 3/8 API REG R/P	8	OS (3.782)	
300ZAQ/13	BIT DHM 2 3/8 API REG R/P 10 OS 3.782	3 3/8 API REG R/P	10	OS (3.782)	

THIS PAGE LEFT INTENTIONALLY BLANK

DRILLING GUIDELINES

DRILLING GUIDELINES 140

IMPREGNATED DIAMOND BITS.....	140
SURFACE-SET DIAMOND BITS.....	144



DRILLING GUIDELINES

Impregnated Diamond Bits

This section of the catalog is intended to provide you with some guidelines which may assist in maximizing the performance of your Boart Longyear® bit.

SOFT ROCK FORMATIONS

- Low RPM's
- Large diamonds/cutters
- Large waterways for better flushing and higher GPM flow rates
- Hard matrix for longer bit life

HARD ROCK FORMATIONS

- High RPM's
- Small diamonds/cutters
- Small waterways
- Soft matrix to expose more cutting elements

ROTATIONAL SPEEDS

Most drillers adopt the practice of choosing the rpm and bit weight they wish to use and then adjust the fine feed control to maintain this particular weight as minor variations in the formation are encountered.

As a rule, impregnated diamond bits require higher rotational speeds to achieve penetration rates comparable with those of surface set bits. This is simply because the diamond exposure (protrusion of the diamond) is less with an impregnated bit and consequently penetration per revolution is less.

With impregnated bits, Boart Longyear recommends a quite different approach in which penetration rates are controlled with a fairly narrow range for a given rpm and the bit weight is of secondary importance. This procedure is known as the rpi (r/cm) method of drilling.

DRILLING GUIDELINES

RPI

The rpi index (bit revolutions per inch of penetration) or r/cm (bit revolutions per cm of penetration) is a most important device in achieving maximum bit life, lowest bit cost and good productivity.

To calculate the rpi (r/cm) index, divide the rotational speed (rpm) of the bit by the rate of penetration, i.e., 800 rpm divided by 4 in/min = 200 rpi (800 rpm divided by 10 cm/min = 80 r/cm)

IDEALLY AIM FOR 200-250 RPI (80 – 100 R/CM)

Providing you work within this guideline and the bit selected matches the formation, drilling should progress smoothly and the bit will wear at a more or less constant rate over its entire life.

If rpi (r/cm) is below the recommended minimum of 200 (80), excessive wear can occur so you should either increase rpm or decrease penetration rate by reducing bit weight. If ground conditions or drill limitations prevent you from making these adjustments, change to a lower number bit; i.e., SERIES 9 to an SERIES 7.

If rpi (r/cm) index is much above the recommended maximum of 250 (100), the bit may “polish” so you should reduce rpm or increase penetration rate by increasing bit weight. If rpm or weight cannot be altered, change to a higher numbered bit (i.e., a SERIES 2 to a SERIES 6).

Polishing, glazing or closing-up are terms commonly used to describe a condition where the face of the bit becomes metal bound and no diamond points protrude from the matrix to cut the rock.

Penetration virtually ceases and it becomes necessary to “strip” the bit down the hole or otherwise re-expose the diamond. It is of the utmost importance, in order to avoid polishing, that the driller should keep the bit cutting.

BIT WEIGHT

Although we have stated earlier that bit weight is only of secondary importance when drilling impregnated bits, we realize that it can become an important factor in some circumstances. This is especially true where limitation of the down-hole tools to withstand high thrusts is being approached, or where deviation control is of prime importance.

In such cases, it is suggested that a higher than normally recommended bit should be used, exercising some discretion concerning penetration rates. This will tend to diminish the deviation or down-hole equipment problems at some expense in higher bit costs.

If very high bit loads are required to cut the rock, select a higher bit range. This will normally result in lower bit weights required while maintaining acceptable penetration rates.

The bit weights shown in the chart on the next page are simply intended to indicate the range of weights considered normal for a given size of core barrel. If you exceed the maximum weight listed you can expect deviation to arise, excessive wear of core barrels and rods, and even

DRILLING GUIDELINES

FLUID FLOW

Regulation of fluid pump output by means of a water flow meter, can be a useful technique for assisting the drilling of very hard siliceous formations. If when starting to pump at the highest recommended fluid volume, there shows a need for bit stripping, pump output should be reduced towards the lower end of that recommended in the following chart and this will assist in a minor buildup of cuttings at the bit which will, in turn, abrade the matrix. If polishing or the need to strip the bit continues, a bit change should be made to the next higher bit (i.e., SERIES 6 to a SERIES 7).

Customers are encouraged to use cutting oils or lubricating fluids with bit impregnated bits in hard rock formations only.

IMPREGNATED BIT DRILLING GUIDELINES

Bit weight can be measured on conventional Boart Longyear drills by using the "off pressure" method described in Section 2 (Page 40).

SYSTEM	FLUID VOLUME RANGE		ROTATION SPEED (rpm)	PENETRATION RATES				INDICATIVE BIT WEIGHT RANGE	
	gpm	L/min		in/min		cm/min		lb	kN
				200 rpi	250 rpi	80 r/cm	100 r/cm		
LTK 46	2.5 - 3.5	10 - 13	2,300	11.5	9.2	29	23	1,000-3,000	5-13
			1,400	7	5.6	18	14		
			1,000	5	4	13	10		
LTK 48	2.5-4	11 - 20	2,000	11	8.8	28	22	1,900-3,100	8-14
			1,500	7.5	6	19	15		
			900	4.5	3.6	11	9		
LTK 60	5 - 7	20-25	2,000	8.5	6.8	22	17	2,000-5,000	9-23
			1,700	5	4	13	10		
			1,500	3.5	2.8	9	7		
AQ®/AQ®TK	3 - 5	11 - 15	2,000	10	8	25	20	2,000-5,000	9-23
			1,200	6	4.8	15	12		
			850	4.25	3.4	11	9		
BQ®/BQ®TK	6 - 8	23 - 30	1,700	8.5	6.8	22	17	2,000-5,000	9-23
			1,000	5	4	13	10		
			700	3.5	2.8	9	7		
NQ®	8 - 10	30 - 38	1,350	6.75	5.4	17	14	3,000-6,000	14-27
			800	4	3.2	10	8		
HQ®	10 - 12	38 - 45	1,000	5	4	13	10	4,000-8,000	18-36
			600	3	2.4	8	6		
PQ®	18 - 23	68 - 87	800	4	3.2	10	8	5,000-10,000	23-45
			50,006	2.5	2	6	5		

DRILLING GUIDELINES

PROBLEM SOLVING AND TIPS

Much can be learned from examining impregnated bits when they are pulled from the hole. The illustrations and observations appearing in troubleshooting guide will help you identify and remedy many of the common field problems.

Normal retirement or discarding of an impregnated bit should only take place after it has been totally consumed. Most Longyear® impregnated bits have full depth waterways to allow the bit to be fully consumed. The first indicator that a bit is nearing normal retirement is a rise or kick in pump pressure due to the diminishing depth of waterways.

Ideally, an impregnated bit will drill steadily, with the matrix and diamond wearing away at the same rate.

STRIPPING – IN THE HOLE METHOD

If too low of a Longyear® bit has been selected for the rock type or if an impregnated bit has been allowed to slow down and polish, it is necessary to “open” or “strip” the matrix surface to expose new diamonds. This can usually be accomplished by reducing the spindle rpm by about 1/3 – 1/2 (select a lower gear if you have a transmission) and maintaining a constant penetration rate. Bit pressure will build up for approximately 1/2 – 1 in. (1 – 2 cm) of drilling and then the bit pressure will drop quickly, signaling that stripping has occurred and the bit is cutting freely again. Immediately reduce bit pressure and increase spindle rpms to conform to the correct rpi (r/cm). If it becomes necessary to frequently repeat this process, it is recommended that you change to the next higher bit.

STRIPPING – OUT OF THE HOLD METHOD

Sandblasting the face of the bit with a hard abrasive will restore exposure and allow increased penetration when the bit is returned to the hole.

Notes:

- Stripping is to be avoided as much as possible because it artificially reduces bit life.
- If the bit has to be stripped repeatedly, replace it with a higher bit
- Under no circumstances should any acid be used for stripping a Boart Longyear impregnated bit.
- Shutting off water while drilling and waiting for the bit to “bite” is not recommended as a method of stripping.

DRILLING GUIDELINES

Surface-Set Diamond Bits

OPERATING PARAMETERS

Efficient drilling practice, when using surface set coring bits, calls for a sound balance between rotational speed, bit weight and penetration rate for the specific drilling conditions encountered. If you work within the operating guidelines set out, good drilling progress and economical bit life can be expected.

ROTATIONAL SPEEDS

RPI

BIT WEIGHT

FLUID FLOW

BIT SPEED – SURFACE SET BITS

Bit rpm should normally fall within the recommendations below. High rpm should be avoided in soft formations to prevent hole enlargement. Down-hole vibration should be avoided at any rotational speed.

BIT SIZE	rpm
LTK 48	900 – 2200
AQ®	800 – 1200
AQ®TK	1,000 – 1500
BQ®	600 – 1000
BQ®TK	800 – 1200
NQ®	500 – 800
HQ®	400 – 600
PQ®	350 – 500

BIT WEIGHT

It is difficult to make clear recommendations for surface set bit weights which take into account the many factors influencing bit performance. These include rock formation, condition of hole, diamond quality, and many others.

When using a new surface set bit only sufficient bit weight should be applied to ensure the bit cuts freely at an acceptable penetration rate (usually 2 – 6 in/min, 5 – 15 cm/min).

As the diamond tends to wear, increasing bit weight will become necessary to keep the bit penetrating. Some judgement is necessary in choosing the point at which the bit is retired from service. In the absence of experience in the conditions to be drilled, an approximation of maximum bit weight, when using high quality diamonds, is given by the following formula:

Maximum Bit Weight (lb) = Carat Weight x Average Number of Stones/Carat x 7
Maximum Bit Weight (kg) = Carat Weight x Average Number of Stones/Carat x 3.2
Example: NQ® BIT ~ 16 carats, 45/55 stones/carat
Maximum suggested Bit Weight: 16 x 50 x 7 = 5600lb, 16 x 50 x 3.2 = 2560 kg

DRILLING GUIDELINES

WEIGHT (FORCE) ON THE BIT AND PENETRATION RATE

The weight of the rods and the down force developed by the hydraulic cylinders provide the force exerted on the diamond bit while drilling. This force is difficult to measure directly, but can easily be found by the following “Off Pressure” method:

1. Suspend the rods with the hydraulic swivel head, close the restrictor valve and place the 4-way valve in the lowering position.
2. With the drilling motor running at a fast idle, note the reading on the hydraulic pressure gauge. This is approximately equal to the hydraulic pump pressure plus the weight of the rods in terms of hydraulic pressure.
3. Rotate the rods and feed them down by opening the restrictor valve. As the bit touches bottom, part of the weight of the rods will be supported on the bit. This action is indicated by a decrease in the gauge reading. The difference in the gauge readings is called, “Off Pressure”
4. The “Off Pressure” multiplied by the area of the hydraulic cylinders will give the force on the diamond bit.

FLUID FLOW RATE

The flow of drilling fluid in a hole serves many purposes including the essential cooling of the diamonds and removal of cuttings. The flow rates indicated on the following chart are a useful guide for common combinations of rods and barrels when drilling with surface set bits.

We normally recommend the use of cutting oils or lubricating fluids and a water flow meter when drilling with surface set bits.

SURFACE SET BITS	gpm	L/min
AQ® bit with AQ® Rods:	2 - 3	8 - 12
AQ®TK bit with AQ®TK Rods:	2 - 3	8 - 12
BQ® bit with BQ® Rods:	4 - 5	15 - 19
BQ®TK bit with BQ®TK Rods:	4 - 5	15 - 19
NQ® bit with NQ® Rods:	5 - 7	19 - 26
HQ® bit with HQ® Rods:	6 - 11	23 - 42
PQ® bit with PQ® Rods:	10 - 15	38 - 57
A Size bit with AW Rods:	2 - 3	8 - 12
B Size bit with BW Rods:	5 - 7	19 - 26
N Size bit with NW Rods:	6 - 11	23 - 42
H Size bit with HW Rods:	8 - 13	30 - 50
LTK 48 bit with AWJ, AQ®, AQ®TK OR AW Rods:	2 - 3	8 - 12

THIS PAGE LEFT INTENTIONALLY BLANK

TROUBLE SHOOTING

TROUBLE SHOOTING 148

IMPREGNATED DIAMOND BIT WEAR PATTERNS..... 148



TROUBLE SHOOTING

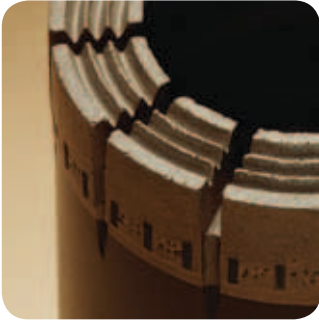

NEW CONDITION



IDEAL WEAR PATTERN

The face wear pattern of an impregnated bit should be relatively flat with slightly chamfered sides. Bit feels sharp, comet tails have formed to support diamonds. Diamonds release from matrix as they are worn. Gauge stays within tolerance.



NORMAL RETIREMENT

Full depth of impregnation evenly consumed. Gauge stays within tolerance.



CONCAVE FACE WEAR (rounded to ID)

Cause: (A) Often caused by excessive penetration rate for the rpm used — rpi (r/cm) too low. Also can be caused by core grinding, overdrilling.



CONCAVE FACE WEAR (rounded to OD)

Cause: (A) Insufficient water flow — Check pump and rod string for leaks; increase pump output.



GAUGE LOSS ID

Cause: (A) Overfeeding — Increase rpi (r/cm); (B) Broken formations — Cement or change to a lower bit; (C) Drilling over lost core — Check core barrel/core lifter/core lifter case; (D) Insufficient drilling fluid — Check inner tube length adjustment; check pump and rod string for leaks — increase pump output.

TROUBLE SHOOTING



GAUGE LOSS OD

Cause: (A) Lack of circulation – increase coolant flow rate. (B) Bit being reamed down under-size hole – Check reamer shell gauge and replace if under-sized. (C) Vibration – alter rpm.



EXCESSIVE DIAMOND EXPOSURE

Matrix abrades away before diamonds have worn sufficiently, resulting in high diamond exposure and low bit life. Caused by overfeeding/over drilling – Increase rpi (r/cm), change to a lower series bit or reduce bit weight rpm.



FACE GLAZED (Diamond polished and metal bound)

Bit does not feel sharp; diamonds flush w matrix; no significant “comet tails” behind each diamond. Sand blast face or use other recommended methods to re-expose diamond. Try again with rpi (r/cm) in the 200/250 (80/100) range. If the face glazes repeatedly, change to a higher bit.



CRACKED WATERWAYS (diamonds polished)

Cause: (A) Excessive bit load; dropped rods; free fall of (wireline) inner tube in dry hole; (B) bit crushed by rod holder, foot clamp or pipe wrench; (C) Pushed down an undersized hole (i.e., reaming shell worn out).



BURNT

Cause: (A) Lack of fluid. (B) Too high a bit weight being used. – Check pump and rod string for leaks, check inner tube adjustment. Maintain coolant flow rates.

CONVERSIONS*

square inch (in ²)	x 645.160	= square millimeter (mm ²)	x 0.00155	= square inch (in ²)
square inch (in ²)	x 6.452	= square centimeter (cm ²)	x 0.155	= square inch (in ²)
square feet (ft ²)	x 0.093	= square meter (m ²)	x 10.764	= square feet (ft ²)
pound-force (lbf)	x 4.448	= Newton (N)	x 0.225	= pound-force (lbf)
kilogram-force (kgf)	x 9.807	= Newton (N)	x 0.102	= kilogram force (kgf)
inch (in)	x 25.4	= millimeter (mm)	x 0.039	= inch (in)
foot (ft)	x 0.305	= meter (m)	x 3.281	= foot (ft)
mile (mi)	x 1.609	= kilometer (km)	x 0.621	= mile (mi)
pound (lb)	x 0.454	= kilogram (kg)	x 2.205	= pound (lb)
ounce (oz)	x 28.350	= gram (g)	x 0.0353	= ounce (oz)
pound-force foot (lbf ft)	x 1.356	= Newton meter (Nm)	x 0.735	= pound-force foot (lbf ft)
pound-force inch (lbf in)	x 0.113	= Newton meter (Nm)	x 8.851	= pound-force inch (lbf in)
horsepower (hp)	x 0.746	= kilowatt (kW)	x 1.341	= horsepower (hp)
kilowatt hour (kWh)	x 3,600,000	= joule (j)	x 0.00000278	= kilowatt hour (kWh)
pound per square inch (psi)	x 6.895	= kilo pascal (kPa)	x 0.145	= pound per square inch (psi)
pound per square inch (psi)	x 0.00689	= mega pascal (MPa)	x 145.03	= pound per square inch (psi)
inch of water (in H ₂ O) @ 60°F	x 248.830	= Newton per square meter (N/m ²)	x 0.00402	= inch of water (in H ₂ O) @ 60°F
degree Fahrenheit (°F) -32	x 0.556	= degree Celsius (°C)	x 1.8+ 32	= degrees Fahrenheit (°F)
feet per second (ft/sec)	x 0.305	= meter per second (m/sec)	x 3.281	= feet per second (ft/sec)
miles per hour (mph)	x 1.609	= kilometer per hour (km/h)	x 0.621	= miles per hour (mph)
U.S. gallon (U.S. gal.)	x 3.785	= litre (l or L)	x 0.264	= U.S. gallon (U.S. gal.)
Imperial gallon (imp. gal.)	x 4.544	= litre (l or L)	x 0.2196	= Imperial gallon (imp. gal.)
cubic inch (in ³)	x 16.387	= cubic centimeter (cm ³)	x 0.061	= cubic inch (in ³)
cubic inch (in ³)	x 0.0164	= litre (l or L)	x 61.02	= cubic inch (in ³)
cubic feet (ft ³)	x 0.0283	= cubic meter (m ³)	x 35.315	= cubic feet (ft ³)
U.S. gallon per minute (gpm)	x 3.785	= litre per minute (L/min)	x 0.264	= U.S. gallon per minute (gpm)
cubic feet per minute (cfm)	x 0.0283	= cubic meter per minute m ³ /min)	x 35.315	= cubic feet per minute (cfm)

OTHER UNITS

1 bar = 0.1 MPa = 14.5 psi

1 kg/cm² = 0.981 bar = 0.0981 MPa

1 kg m = 9.81 Nm = 7.233 lbf ft

1 lb/U.S. gal. = 0.12 kg/L

* Factors have been rounded off for field use.

WARRANTY

Limited Warranty.

- (a) **Consumables.** Boart Longyear warrants for a period of one (1) year after the date of shipment of the consumable products manufactured by it, or the performance of related services, under the Contract, that such consumable products are free from defects in materials and workmanship and such services are performed in a professional and workmanlike manner; provided, however, with respect to consumable products purchased through an authorized Boart Longyear distributor, the warranty period shall commence on the date of purchase by the end-user.
- (b) **Capital Equipment.** Boart Longyear warrants for a period equal to the lesser of (i) one (1) year after the date of shipment, or (ii) the initial 1,000 operating hours. Boart Longyear warrants for a period of six (6) months after the performance of related services that such services are performed in a professional and workmanlike manner.
- (c) **General Terms.** Boart Longyear further warrants that, to the extent applicable, as of the date of shipment or performance, all goods manufactured by it and services performed shall conform to the written specifications agreed between the parties. THIS IS BOART LONGYEAR'S ONLY WARRANTY. BOART LONGYEAR MAKES NO OTHER WARRANTY, INCLUDING WITHOUT LIMITATION, ANY WARRANTY OF MERCHANTABILITY OR FITNESS FOR A PARTICULAR PURPOSE. As a condition to Boart Longyear's warranty obligations, any goods claimed to be defective under the foregoing warranty must be returned to the facility designated by Boart Longyear, which return shall be made promptly upon Purchaser's discovery of the alleged defect. With respect to consumable products purchased through an authorized Boart Longyear distributor, the party making the warranty claim must also deliver to Boart Longyear reasonable evidence of the date of purchase. Boart Longyear shall perform its examination of the goods so returned by Purchaser and shall report the results of its examination to Purchaser within thirty (30) days following its receipt of such goods from Purchaser, or, if longer time is required to complete such examination, within such time as would be required through the exercise of reasonable diligence. As a further condition to Boart Longyear's obligations hereunder for breach of warranty, Purchaser shall offer its reasonable cooperation and assist Boart Longyear in the course of Boart Longyear's review of any warranty claim. If requested by Purchaser, Boart Longyear will promptly repair or replace at Boart Longyear's expense. Goods that are non-conforming according to Boart Longyear's warranty as set forth herein. All removal and installation of goods shall be at Purchaser's expense. Boart Longyear reserves the right to reimburse Purchaser for an amount equal to the purchase price of any defective goods in lieu of providing repaired or replacement goods. Anything contained herein to the contrary notwithstanding, in no event shall Boart Longyear be liable for breach of warranty or otherwise in any manner whatsoever for: (i) normal wear and tear; (ii) corrosion, abrasion or erosion; (iii) any goods, components, parts, software or services which, following delivery or performance by Boart Longyear, has been subjected to accident, abuse, misapplication, modification, improper repair, alteration, improper installation or maintenance, neglect, or excessive operating conditions; (iv) defects resulting from Purchaser's specifications or designs or those of its contractors or subcontractors other than Boart Longyear; (v) defects associated with consumable parts or materials, the lifetime of which is shorter than the warranty period set forth in this Section; (vi) defects associated with Purchaser's specifications or designs or those of its contractors or subcontractors other than Boart Longyear; (vii) defects resulting from the manufacture, distribution, promotion or sale of Purchaser's own products; or (viii) accessories of any kind used by the Purchaser which are not manufactured by or approved by Boart Longyear.
- (d) **Sourced Goods.** If the defective parts or components are not manufactured by Boart Longyear, the guarantee of the manufacturer of those defective parts or components is accepted by the Purchaser and is the only guarantee given to the Purchaser in respect of the defective parts or components. Boart Longyear agrees to assign to the Purchaser on request made by the Purchaser the benefit of any warranty or entitlement to the defective parts or components that the manufacturer has granted to Boart Longyear under any contract or by implication or operation of law to the extent that the benefit of any warranty or entitlement is assignable.
- (e) **Limitation on Liability.** Except as provided for herein, in no event will Boart Longyear be liable for any indirect, incidental, special, consequential, punitive or similar damages including, but not limited to, lost profits, loss of data or business interruption losses. In no event will the total, aggregate liability of Boart Longyear under the Contract exceed the value of the Contract under which liability is claimed. The liability limitations shall apply even if Boart Longyear has been notified of the possibility or likelihood of such damages occurring and regardless of the form of action, whether in contract, negligence, strict liability, tort, products liability or otherwise. The parties agree that these limits of liability shall survive and continue in full force and effect despite any termination or expiration of any Contract. Any action by Purchaser against Boart Longyear must be commenced within one year after the cause of action has accrued. No employee or agent of Boart Longyear is authorized to make any warranty other than that which is specifically set forth herein. The provisions in any specification, brochure or chart issued by Boart Longyear are descriptive only and are not warranties.



GLOBAL PRODUCT CATALOGUE

LONGYEAR® BITS AND ACCESSORIES

Global Headquarters

Boart Longyear
10808 South River Front Parkway
Suite 600
South Jordan, Utah 84095
United States of America
info@boartlongyear.com

Tel: +1 801 972 6430
Fax: +1 801 977 3374

Latin America

Boart Longyear
Las Dalias 2900 (Macul)
Santiago, 6900959, Chile
info@boartlongyear.com

Tel: +56 2 520 7900
Fax: +56 2 755 0722

Canada

Boart Longyear
1111 Main St. West
North Bay, Ontario
Canada P1B 8H6
info@boartlongyear.com

Tel: +1 705 474 2800
Fax: +1 705 474 2373

Europe

Boart Longyear
Columbusweg 8
5928 LC Venlo
The Netherlands
infoEU@boartlongyear.com

Tel: +31 077 850 58 50
Fax: +31 077 850 58 51

Asia Pacific

Boart Longyear
919-929 Marion Road
Mitchell Park
South Australia 5043
info_au@boartlongyear.com

Tel: +61 8 8375 8375
Fax: +61 8 8377 0539

Sub-Saharan Africa

Boart Longyear
Cycad House, Constantia Office Park
Cnr 14th Avenue and Hendrik Potgieter
Weltevreden Park, 1709
Gauteng, South Africa
infosasa@boartlongyear.com

Tel: +27 11 767 9300
Fax: +27 11 767 9301



www.boartlongyear.com